

Wall Switches

Wiring Diagrams

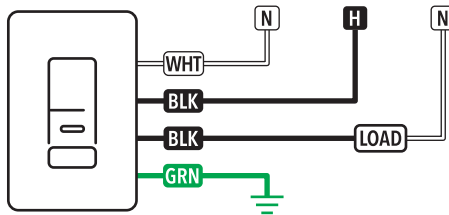

1-POLE NEUTRAL/GROUND



1-POLE GROUND

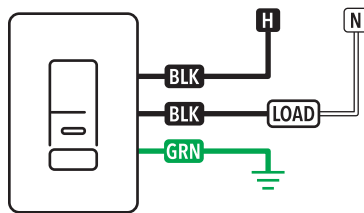

2-POLE NEUTRAL/GROUND

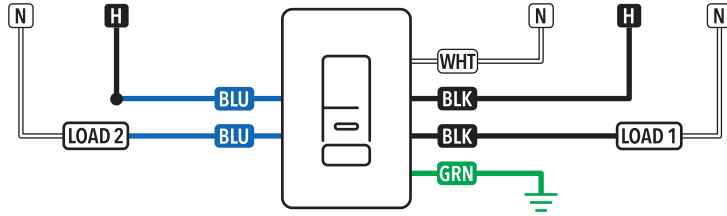

2-POLE GROUND

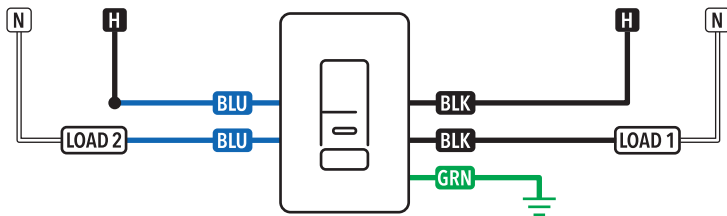

SSD 120

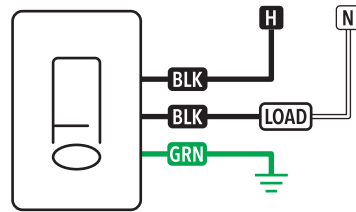

PRESET TIMER SWITCH

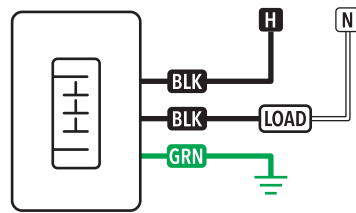

LOW VOLTAGE

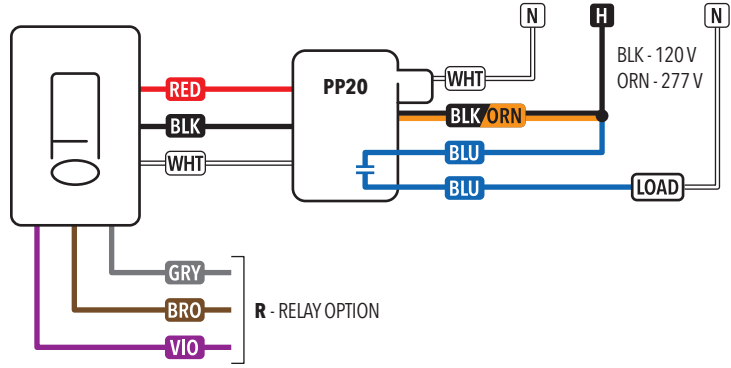

3-WAY WIRING

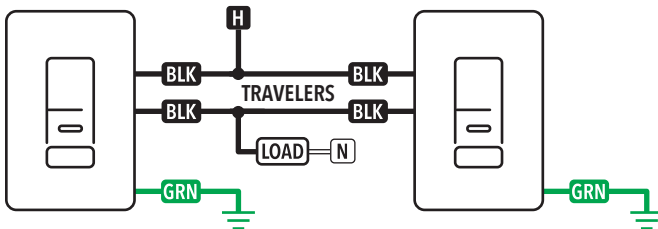

Both sensors required to time out to switch LOAD off

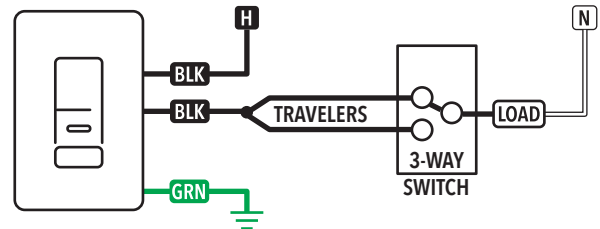

3-way switch does not influence LOAD status