

*Sensor Switch*TM

STANDARD SENSORS BASIC TRAINING

STANDARD SENSORS BASIC TRAINING

- 1 Sensor Switch Overview
- 2 Why Sensors?
- 3 Detection Technology
- 4 Daylight Harvesting
- 5 Standard Sensor Product Line
- 6 Selling Sensor Switch

SENSOR SWITCH OVERVIEW

SENSOR SWITCH OVERVIEW

The Sensor Switch product line of stand alone occupancy sensors and indoor/outdoor daylight controllers are engineered to provide solutions for a multitude of applications, including energy code compliance.

AcuityControls[™]

Sensor Switch[™]

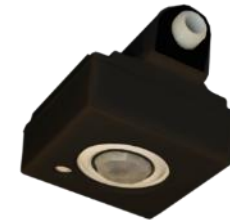

AcuityControls[™]



WHY SENSORS? UNDERSTANDING THE NEED

WHY SENSORS?

- + Convenience
- + Increased Building Security
- + Energy Savings



POTENTIAL ENERGY SAVINGS FROM OCCUPANCY SENSORS

- + 40%-46% in Classrooms
- + 13%-50% in Private Offices
- + 30%-90% in Restrooms
- + 22%-65% in Conference Rooms
- + 30%-80% in Corridors
- + 45%-80% in Storage Areas

Source: US Environmental Protection Agency

WHY SENSORS?IT'S THE LAW

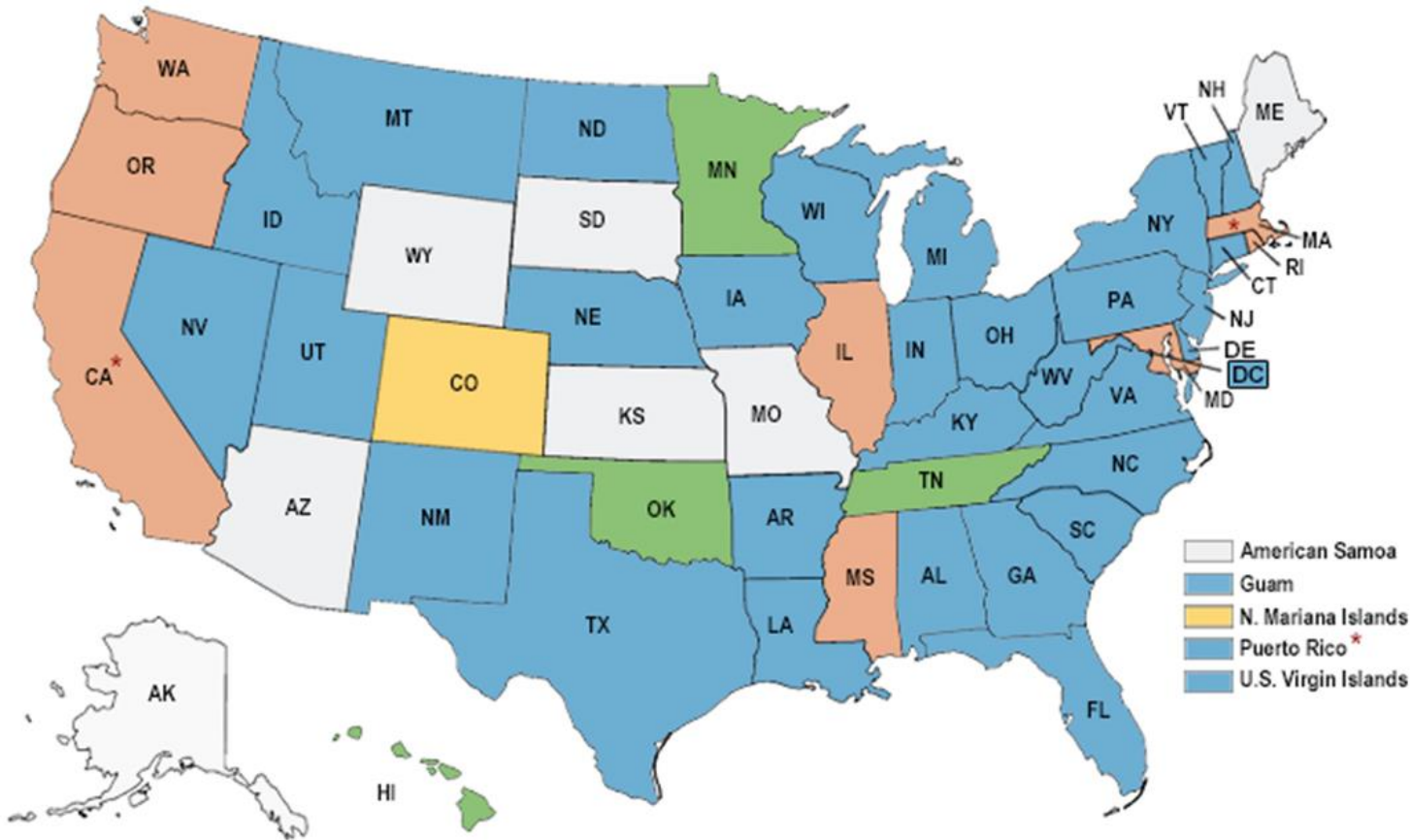

8 ASHRAE 90.1-2010/2012 IECC equivalent or more energy efficient	34 ASHRAE 90.1 - 2007/2009 IECC equivalent or more energy efficient	4 ASHRAE 90.1 - 2004/2006 IECC equivalent or more energy efficient
2 ASHRAE 90.1 - 2001/2003 IECC equivalent or less energy efficient	8 No Statewide Code	



2012 INTERNATIONAL ENERGY CONSERVATION CODE
A Member of the International Code Family
IECC

* Adopted new Code to be effected at a later date

As of October 2013



DETECTION TECHNOLOGY HOW IT WORKS

OCCUPANCY SENSOR TECHNOLOGY

- + Passive Infrared (PIR)
- + Active Dual Technology (PIR & Ultrasonics)
- + Passive Dual Technology (PIR & Microphonics™)

INFRARED (IR) RADIATION

Infrared (IR) is invisible radiant energy, electromagnetic **radiation** with longer wavelengths than those of visible light, extending from the nominal red edge of the visible spectrum at 700 nanometers (frequency 430 THz) to 1 mm (300 GHz) (although people can see infrared up to at least 1050 nm in experiments).

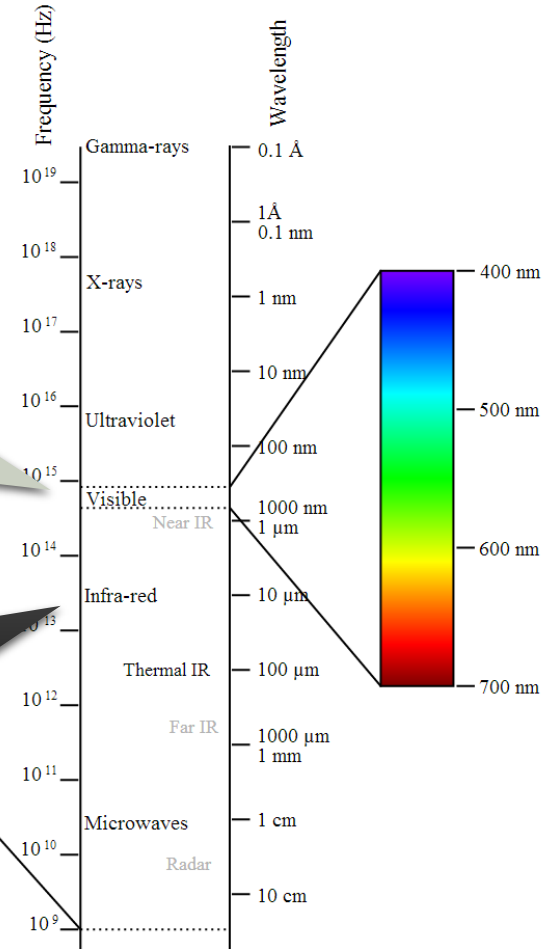

PASSIVE INFRARED (PIR) SENSOR

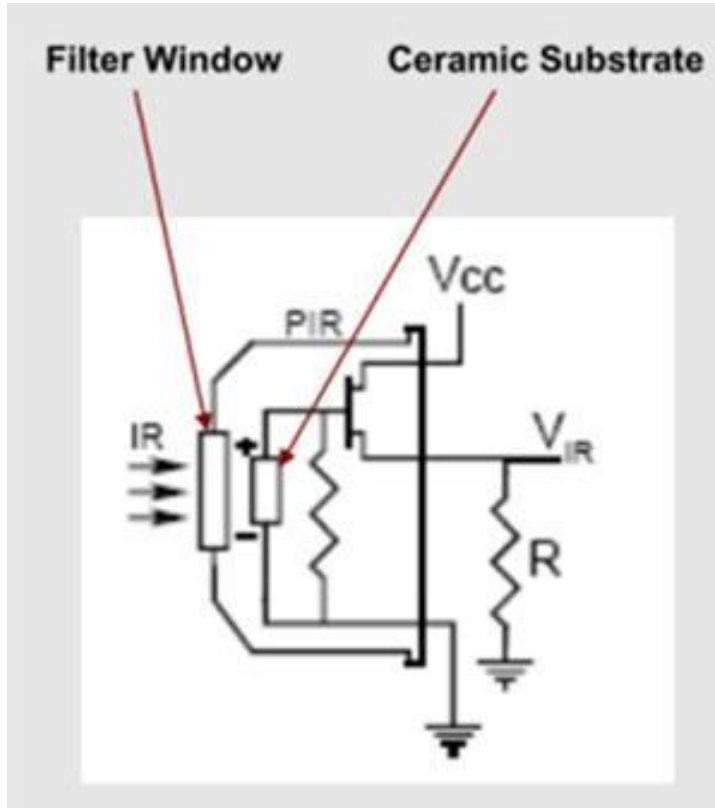

FRESNEL LENS

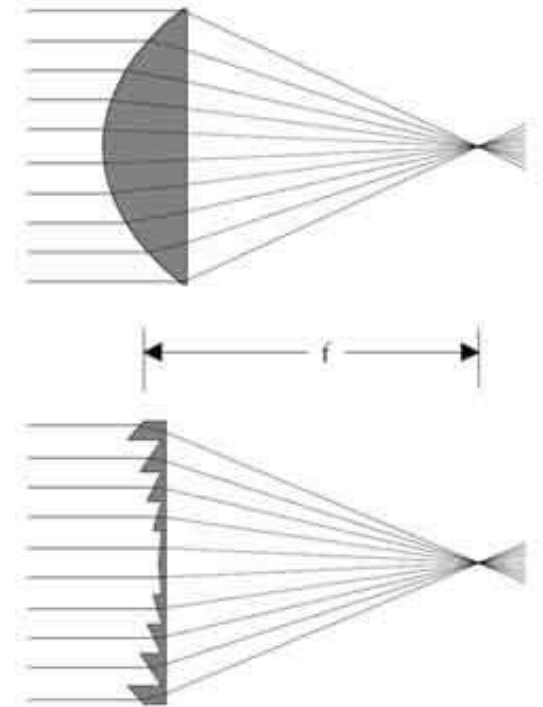
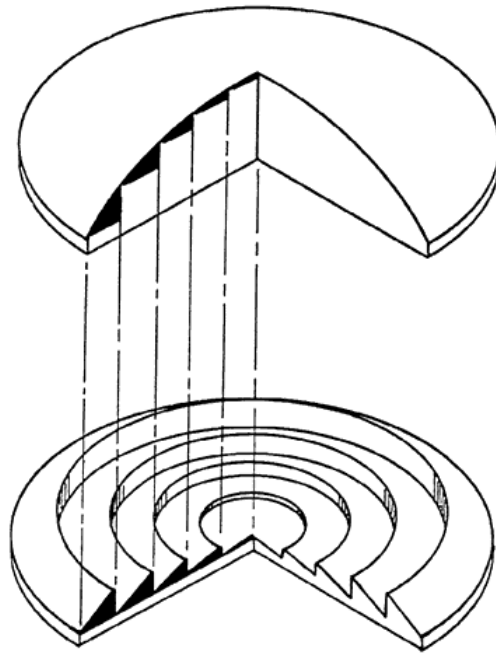
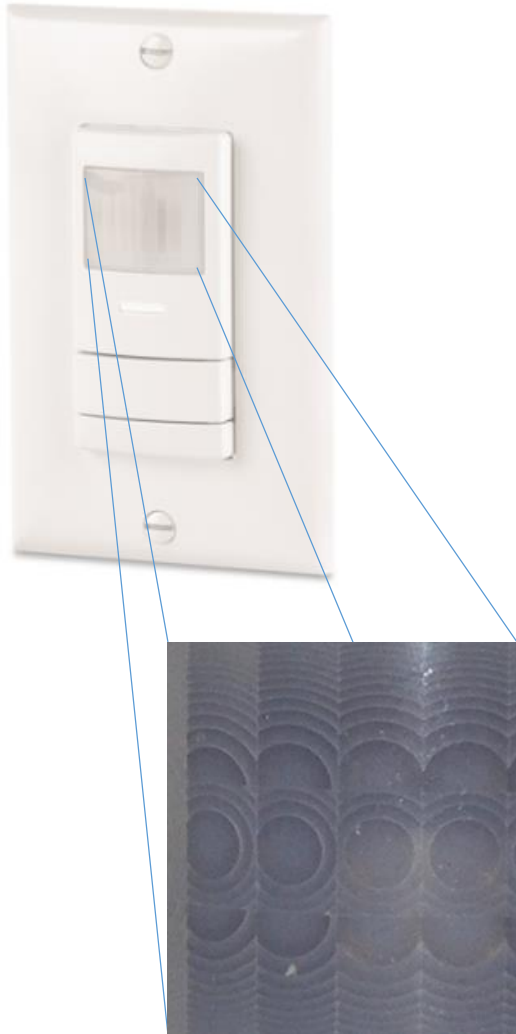

DETECTION SEGMENT

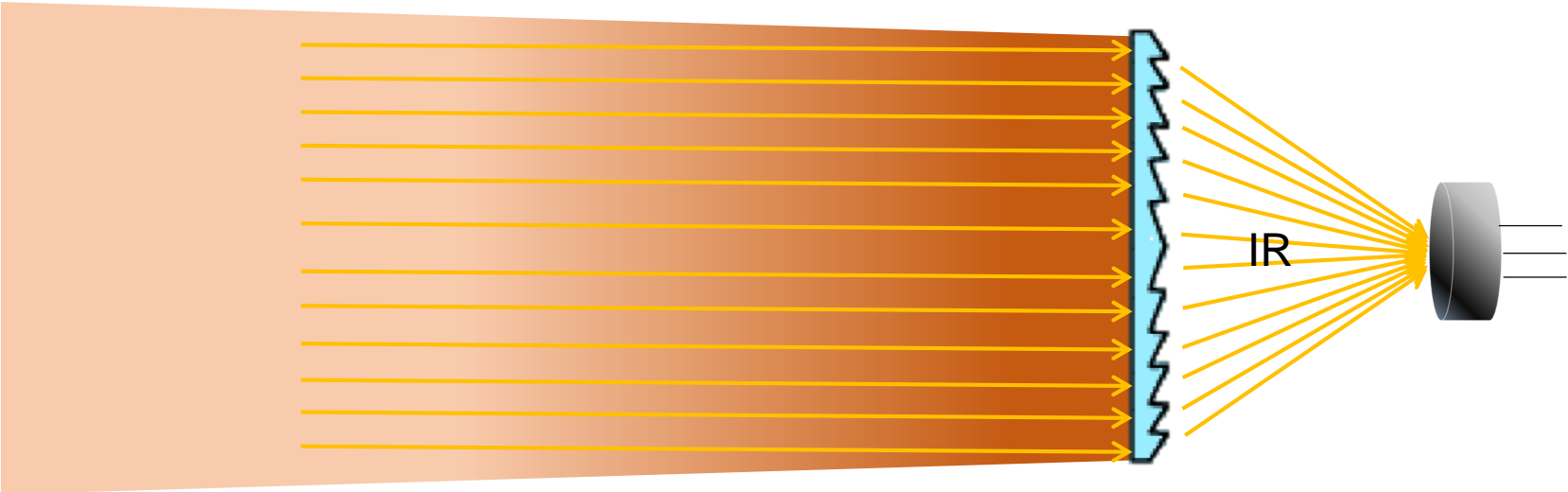

Detection Segment

Fresnel Lens

PIR Detector

MULTIPLE FACETED SENSOR LENS



ARRAY OF DETECTION SEGMENTS

CEILING MOUNT ARRAY CM 0.77 GI V5

FRONT VIEW :

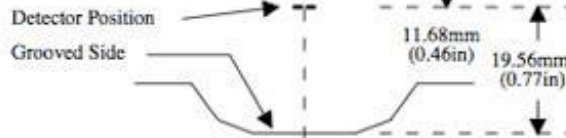

TOP VIEW:

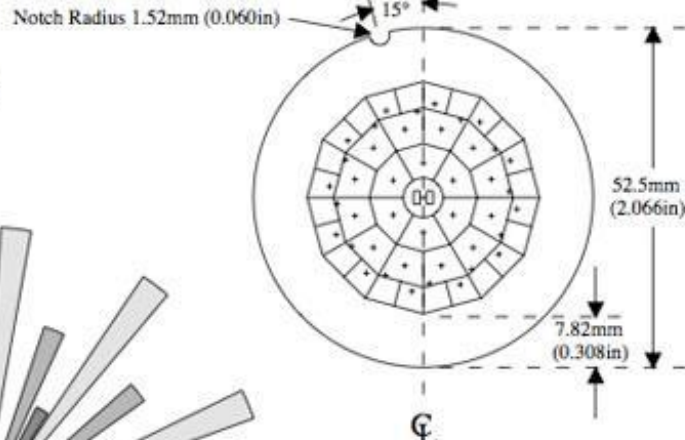
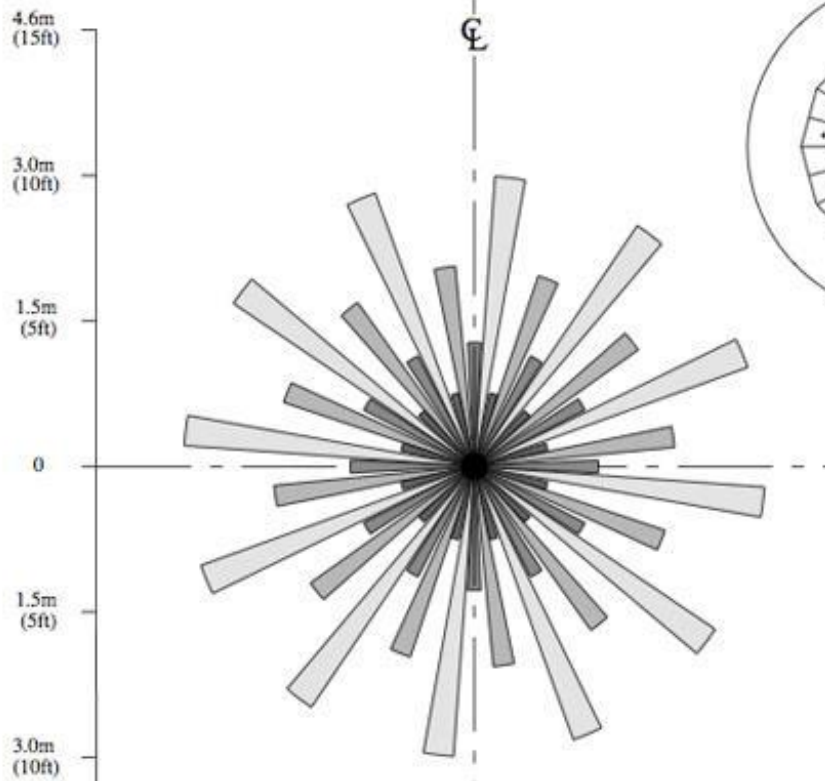

SIDE VIEW:

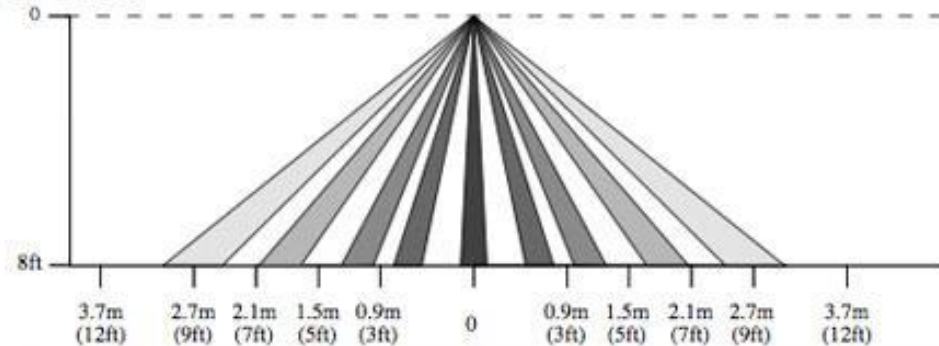

fresnel technologies inc.
© 2008

101W. MORNINGSDR. FORT WORTH, TX 76110, U. S. A. (817) 926-747

OCCUPANCY DETECTION

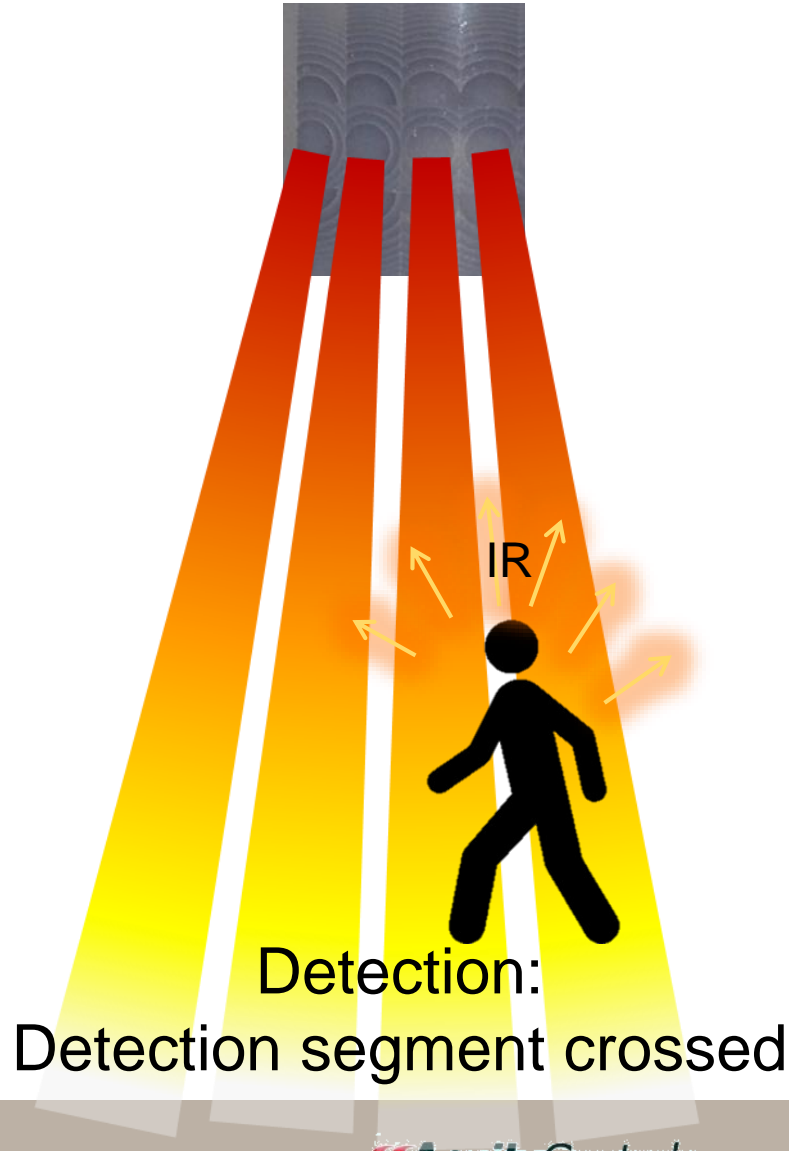
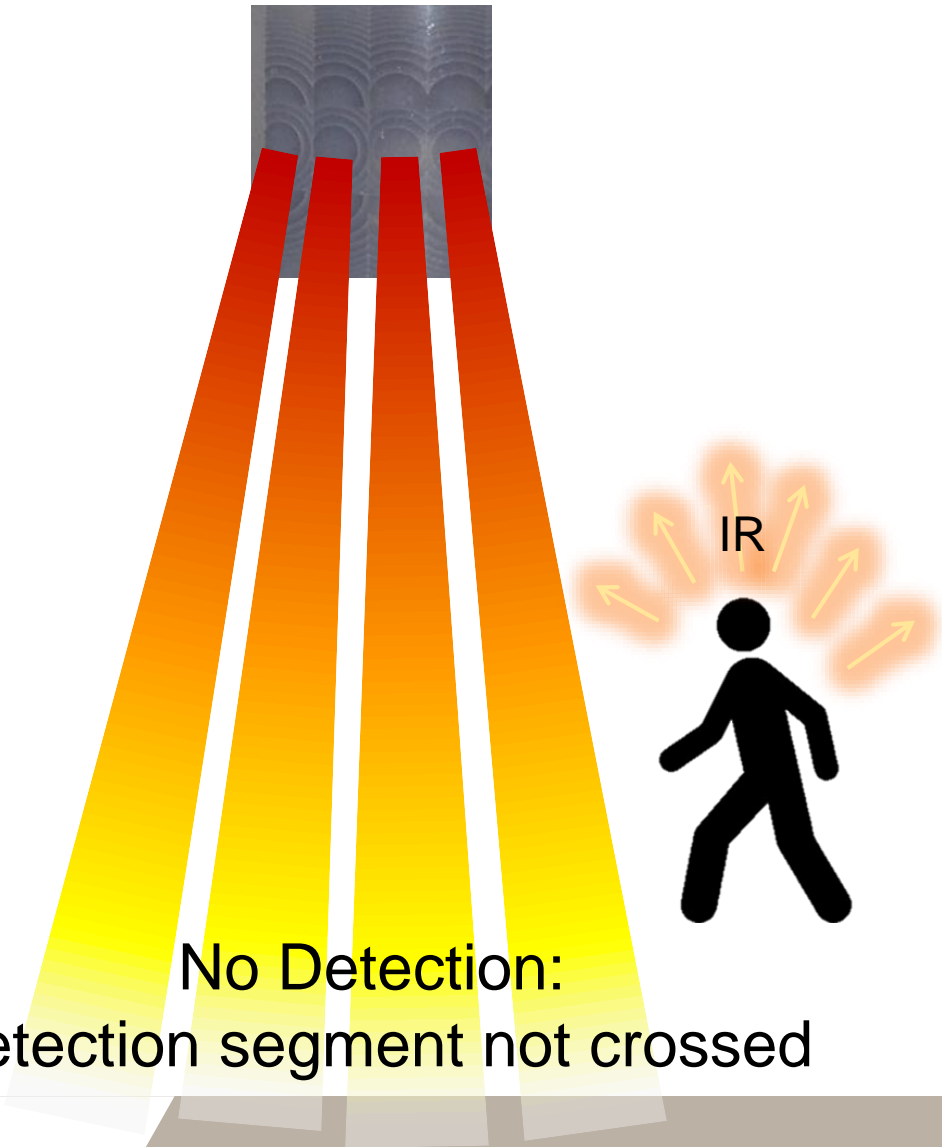

LENS GEOMETRY AND DETECTION CHARACTERISTICS



Less Fresnel Lens Facets = Larger
Detection segment :
For Large Motion / Large Objects



More Fresnel Lens Facets = Smaller
Detection segment :
For Small Motion / Small Objects

CEILING/FIXTURE MOUNTED SENSOR OCCUPANCY DETECTION

Best Detection
Moderate Detection
Poor Detection

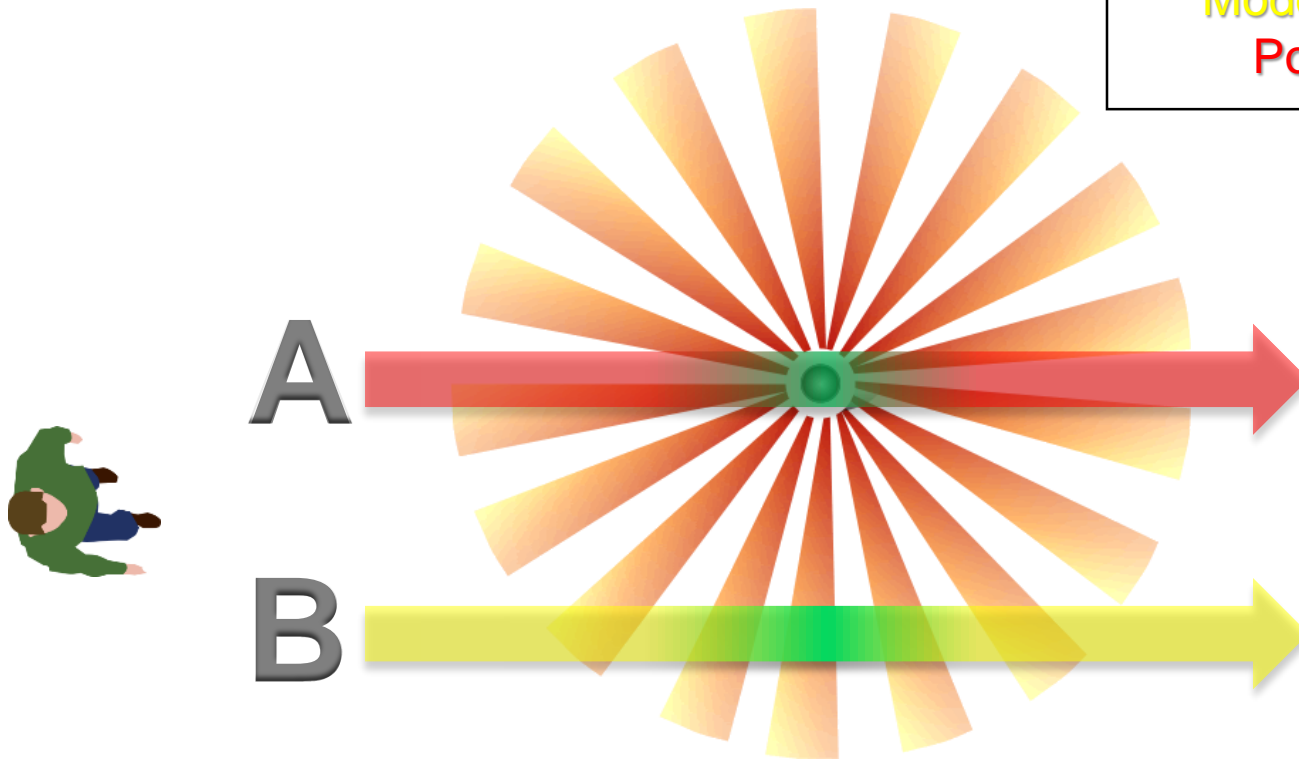

Top Down View

CEILING/FIXTURE MOUNTED SENSOR OPTIMIZED PLACEMENT

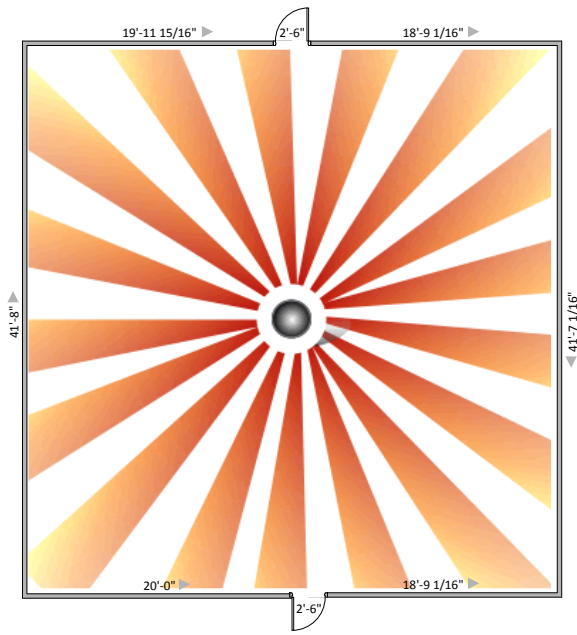

Scenario A

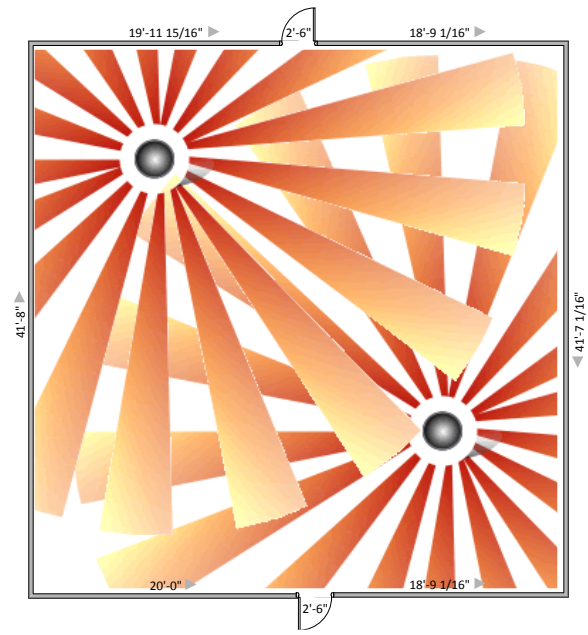

Scenario B

CEILING/FIXTURE MOUNTED SENSOR OPTIMIZED MOUNTING HEIGHT

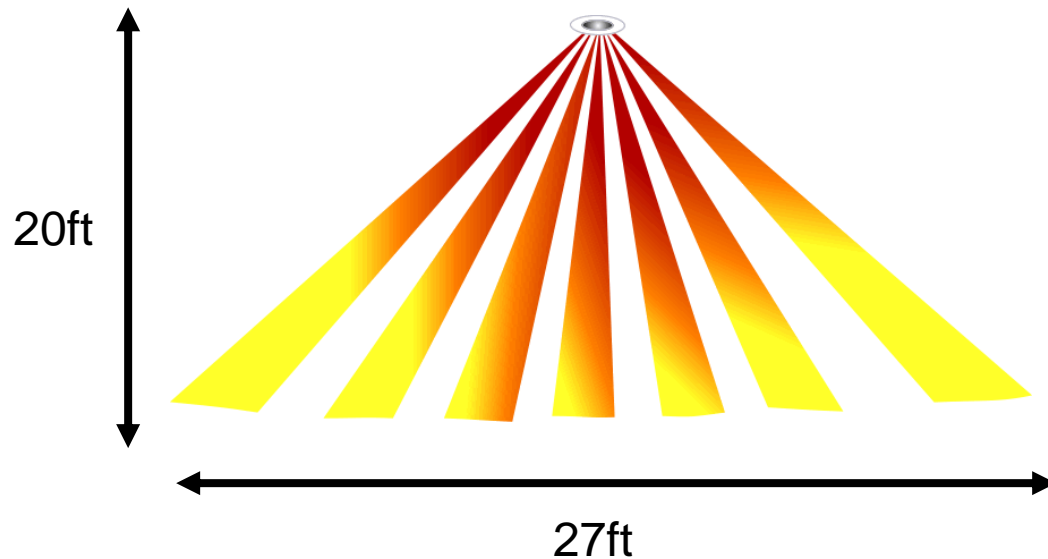

- Installed at recommended height
- Coverage pattern per specification

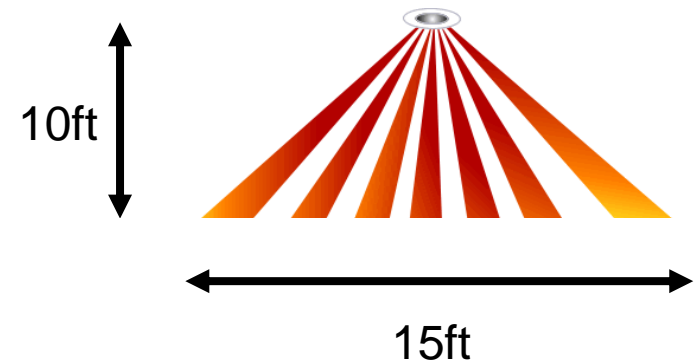

- Installed at lower height
- Coverage pattern limited

WALL/HALL MOUNTED SENSOR OPTIMIZED PLACEMENT



Unobstructed Line of Sight



Obstructed Line of Sight

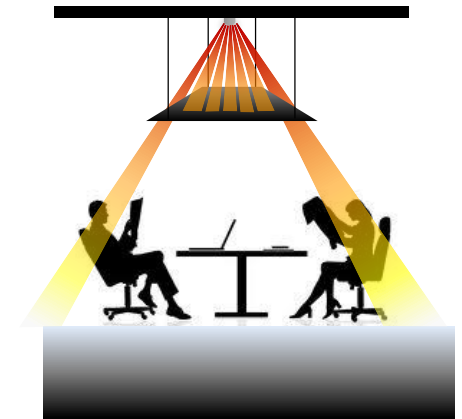

PIR OCCUPANCY DETECTION SUMMARY

- + Detection is dependent on occupant crossing detection segments
- + *Line of sight* required therefore installation height, position and orientation are critical
- + Size (large vs small) of *detection segments* correlate to *the required amount of motion* needed to establish occupancy

NOT ALL PIR'S ARE EQUAL

 **AcuityControls**TM

*Sensor Switch*TM

- + Allows a more energy-saving time delay setting, no false offs
- + No sensitivity adjustments required – install and use
- + Lower frequency response delivers excellent small motion detection at greater distances
- + Each sensor is fine-tuned for optimum detection for its coverage pattern

UNDERSTANDING DUAL TECHNOLOGY

ACTIVE DUAL TECHNOLOGY (ADT) PIR & ULTRASONICS

PIR

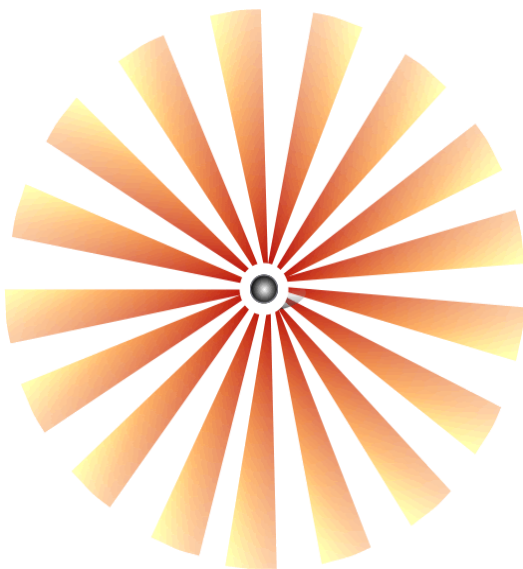

Ultrasonics

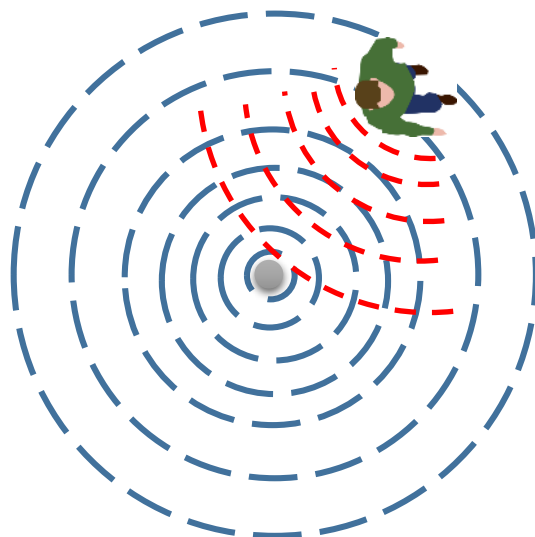

Active Dual Technology

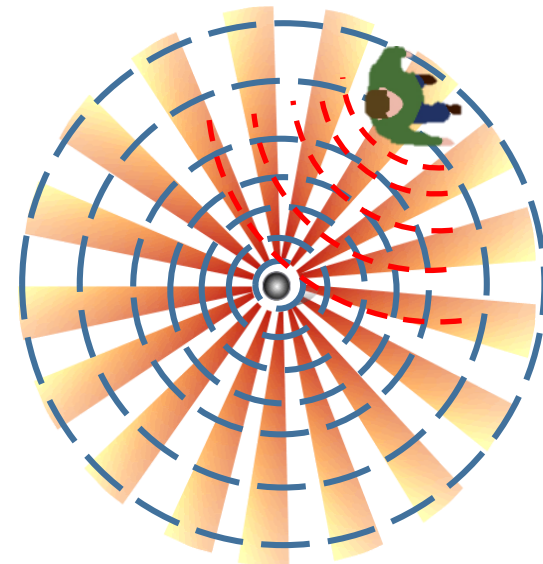

PIR Detection Segments



Transmitted Signal



Reflected Signal

- + Transmits and receives ultrasonic signals in conjunction with PIR to determine occupancy
- + Utilized by competitors

PASSIVE DUAL TECHNOLOGY (PDT) PIR & MICROPHONICS™

PIR

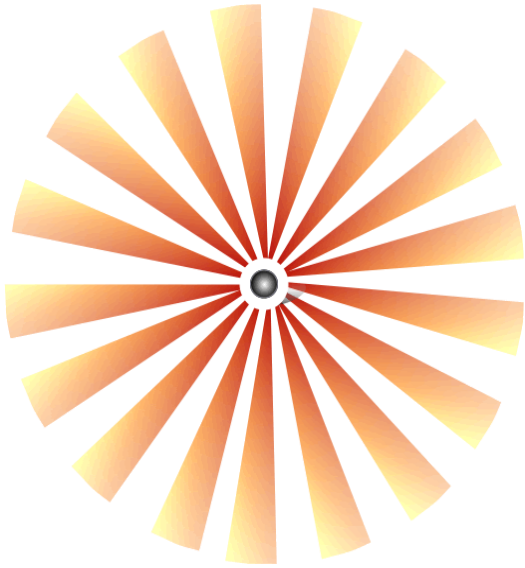

Microphonics™

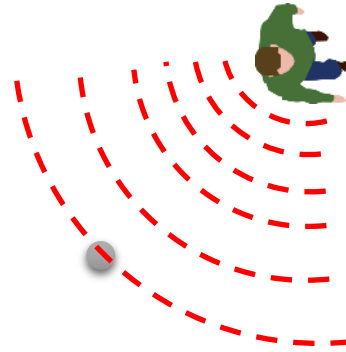

Passive Dual Technology

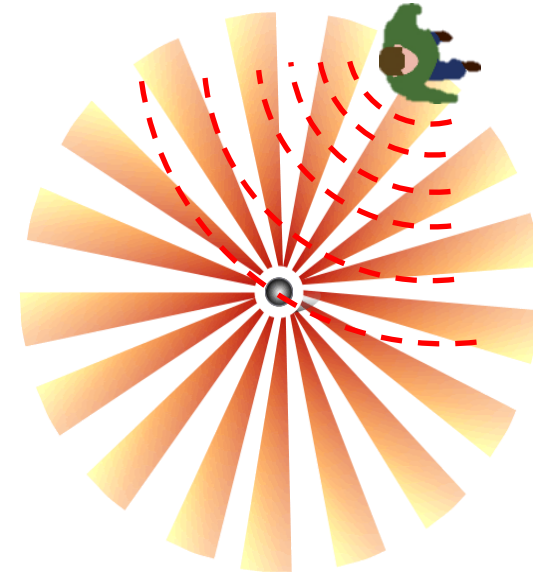

PIR Detection Segments

Sound Wave

- + PDT is a patented Sensor Switch technology
- + Listens for acoustics in conjunction with PIR to determine occupancy
- + Low power consumption

MICROPHONICS™ AUTOMATIC GAIN CONTROL (AGC)

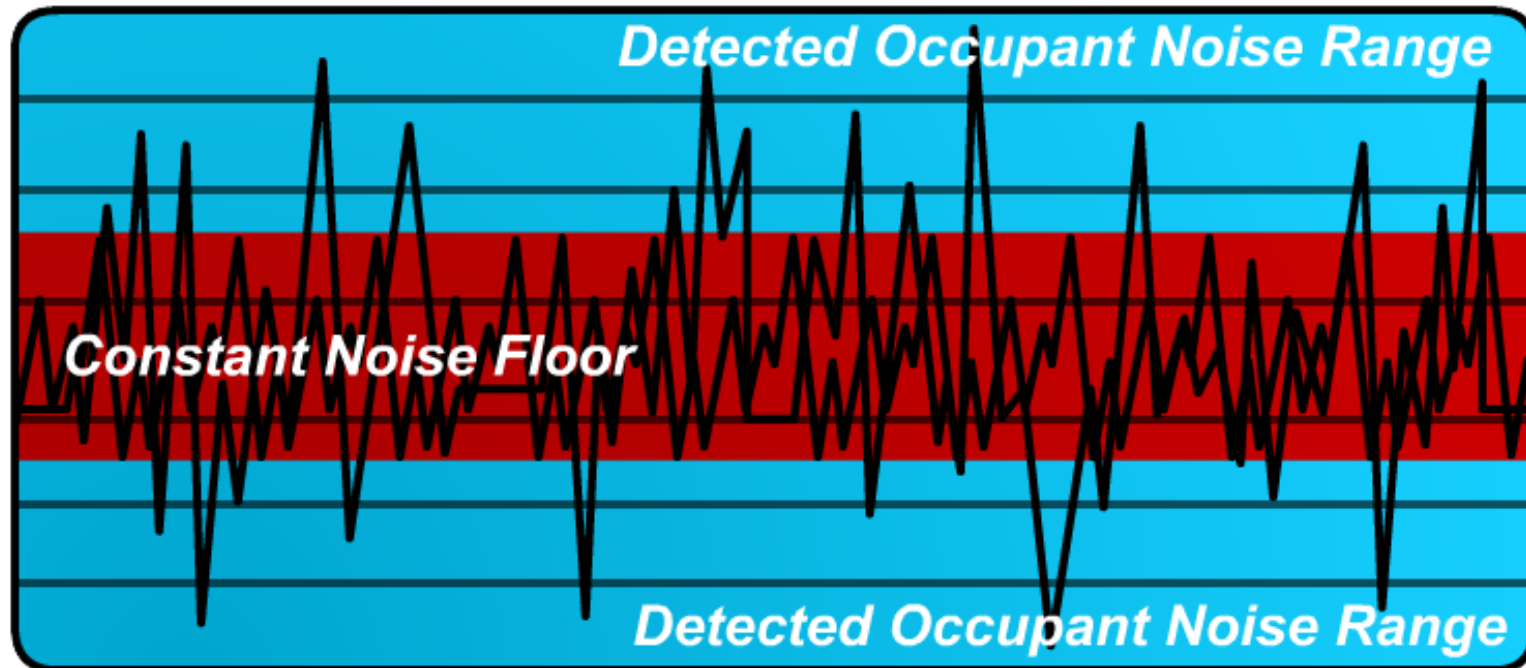

PASSIVE DUAL TECHNOLOGY (PDT) PIR & MICROPHONICS™ APPLICATIONS

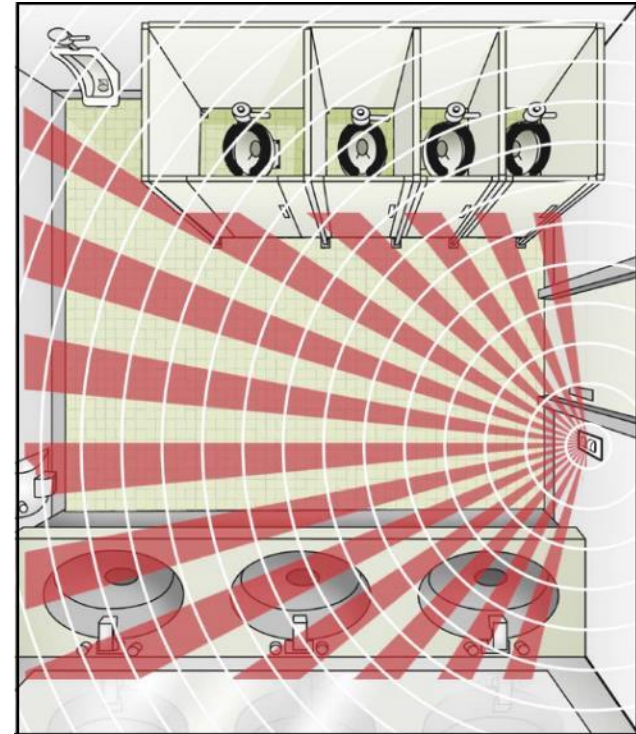
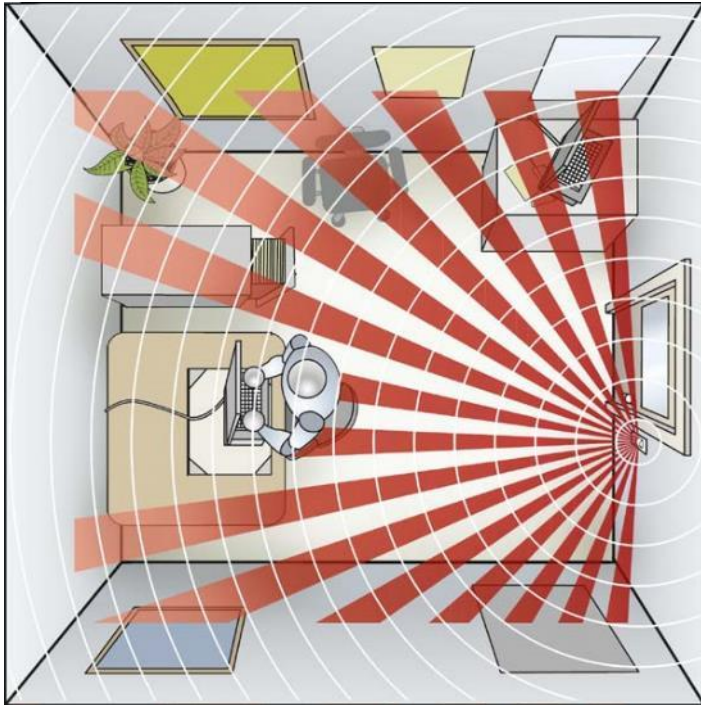

PASSIVE DUAL TECH (PIR & MICROPHONICS™) ADVANTAGES

- + Better & more reliable detection
 - + No false ons from common building motion
 - + Detecting both sound and motion results in better occupant detection than sensors that use two technologies to only detect motion (and thus no false offs).
- + Requires less power
- + Acoustically Passive - sensors transmit no sound waves, thus eliminating all potential for interference

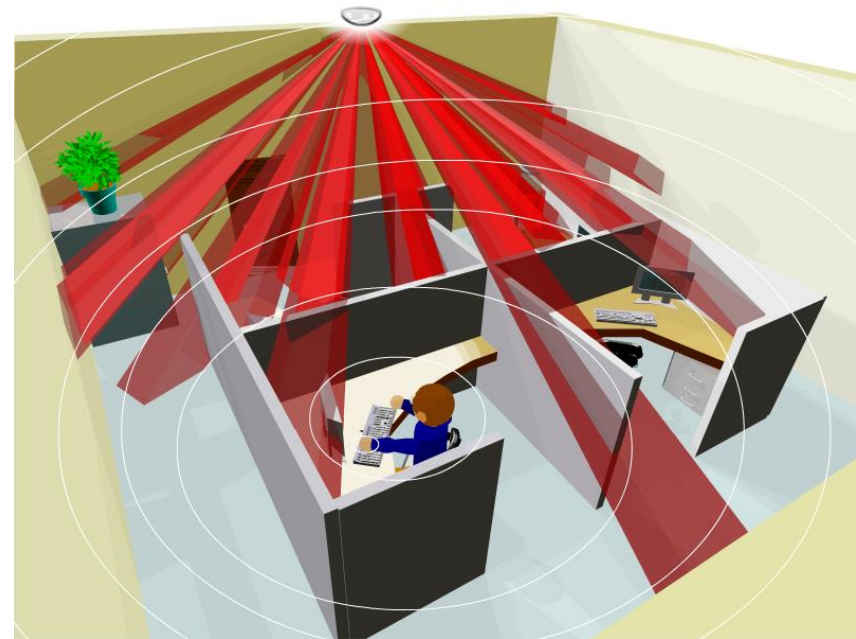



DAYLIGHT HARVESTING

DAYLIGHT HARVESTING



The concept of daylight harvesting is to use digital photo sensors to detect daylight levels and automatically adjust the output level of electric lighting to create a balance. The goal is energy savings.

DAYLIGHT HARVESTING METHODS

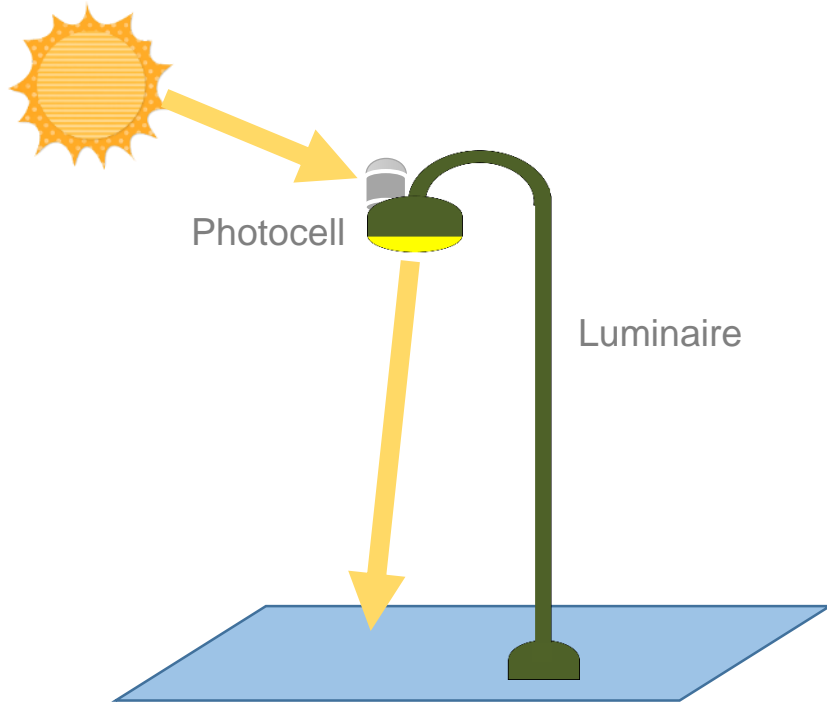

+ Open Loop

+ Photocell operates without feedback from the controlled light source

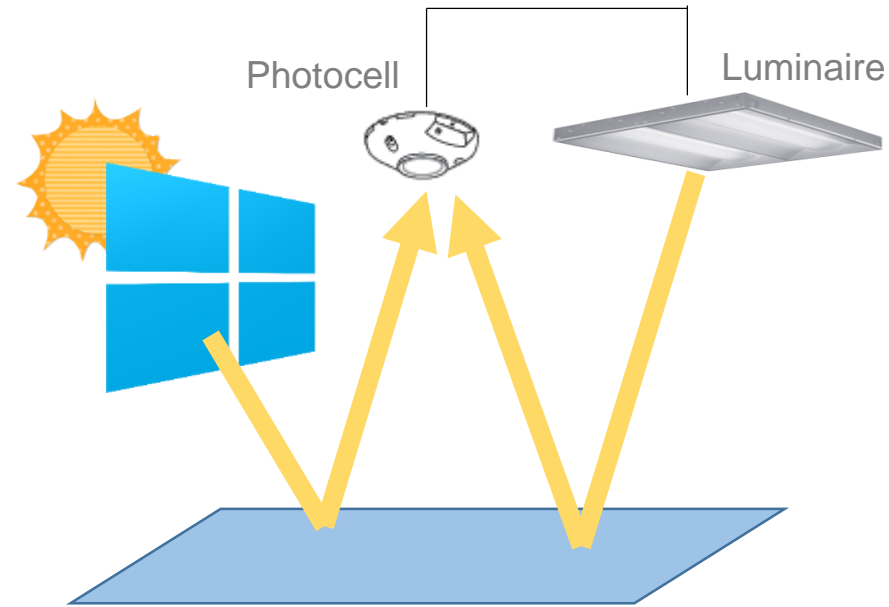

+ Closed Loop

+ Photocell operates with feedback from the controlled light source

DAYLIGHTING CONTROLS SET POINT

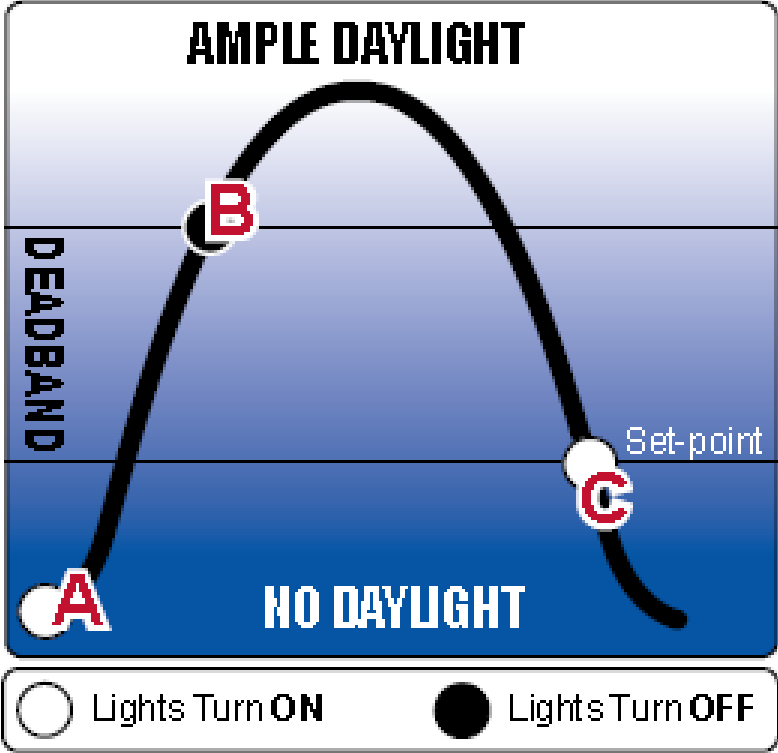

VARIABLE AFFECTS ON SET POINT

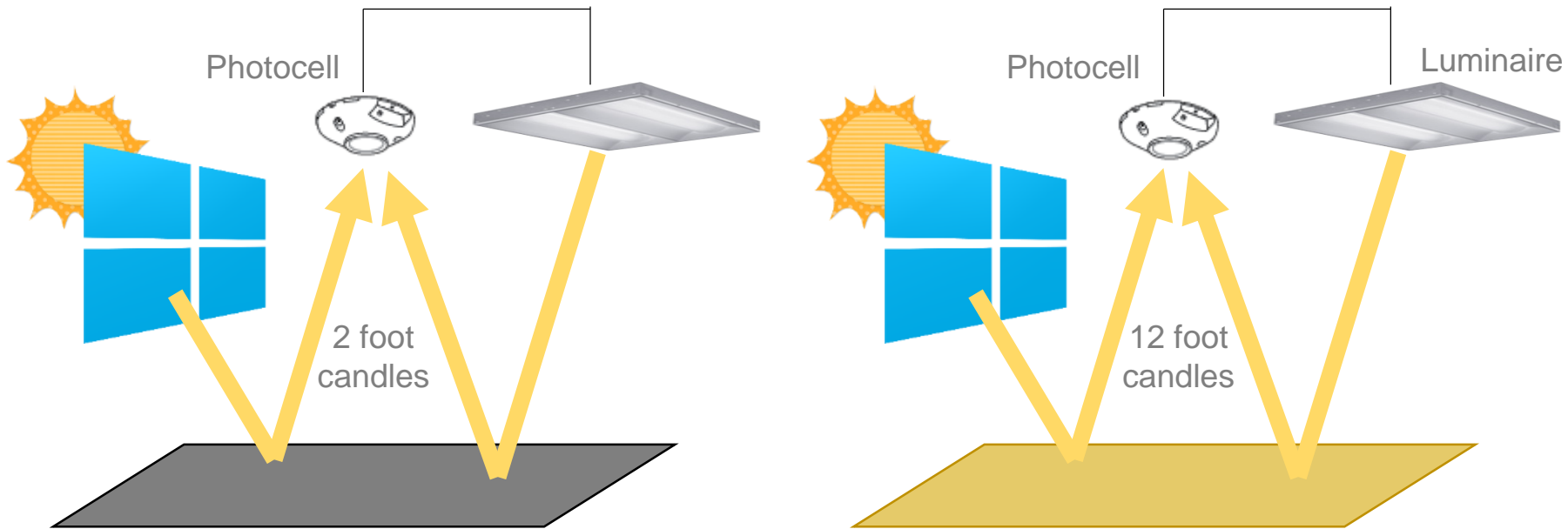

- + Color of the metered surface / floor
- + Furnishings
- + Photocell placement in respect to daylighting

DAYLIGHTING MODES OF OPERATION

- + Automatic On/Off (PC)
- + Automatic Dimming Control (ADC)
- + Combination On/Off and Dimming Control (PC ADC)

AUTOMATIC ON/OFF (PC)

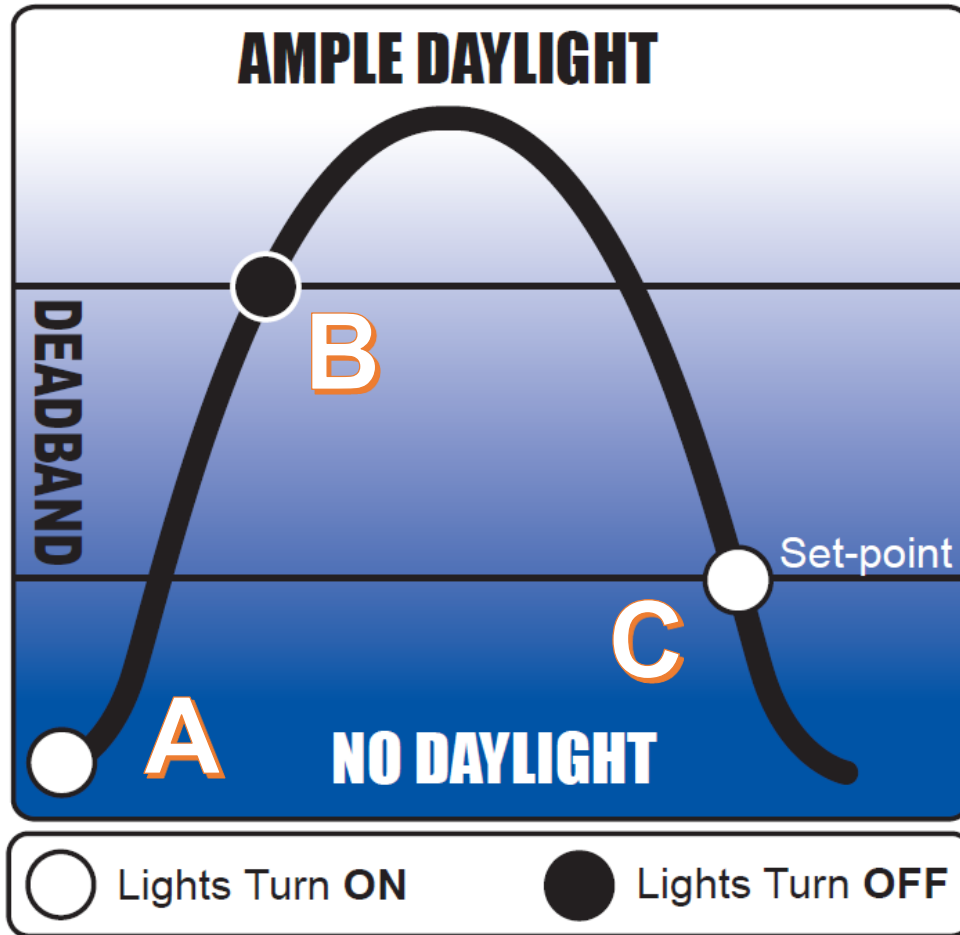

- A. No daylight is available; the lights stay on as normal.
- B. Sufficient daylight is present to maintain the set-point without any contribution from the lights; the lights are switched off. This level is equal to the set-point plus the deadband.
- C. Daylight levels fall below the set-point; the lights switch back on.

AUTOMATIC DIMMING CONTROL (ADC)

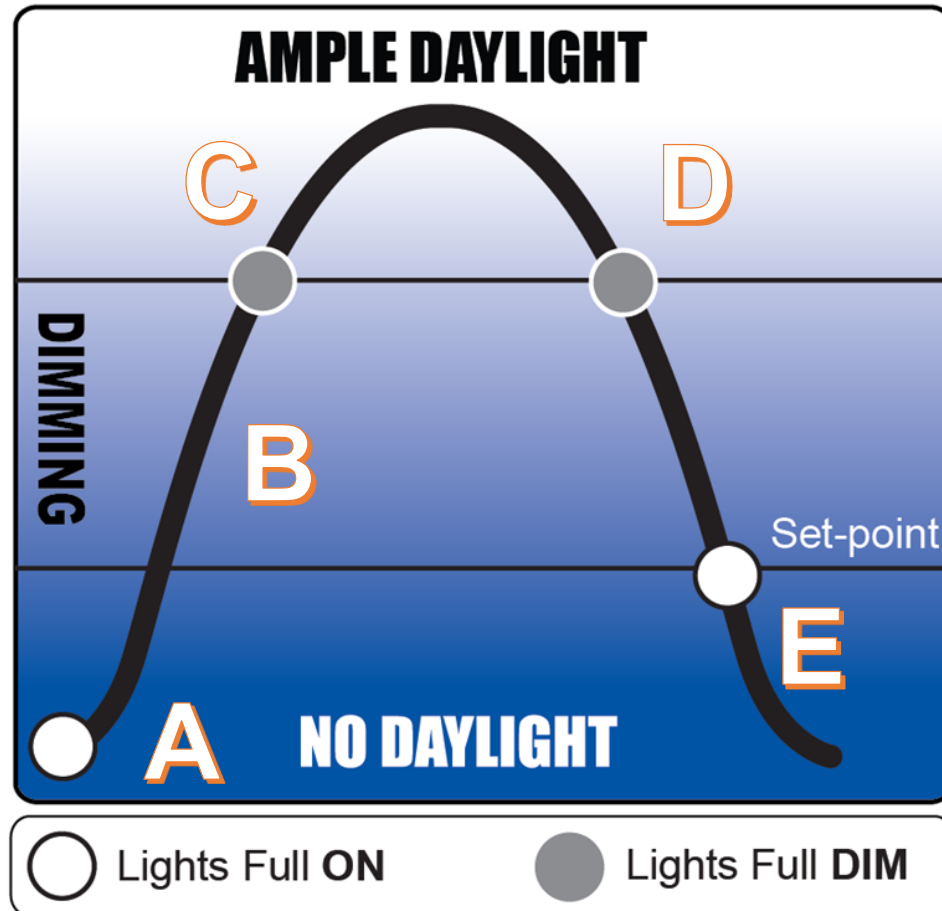

- A. No daylight is available; the dimmable light operates at full bright level (10 VDC)
- B. Increasing daylight begins to contribute to the overall light level; the lights are dimmed proportionally
- C. Sufficient daylight is present to maintain the set-point; the lights are held at its full dim setting (0 VDC).
- D. Daylight levels drop into the dimming range (deadband); the dim level of the light is reduced proportionally.
- E. Daylight levels fall below the set-point; the lights are back to full bright level (10 VDC).

COMBINATION ON/OFF AND DIMMING CONTROL (PC ADC)

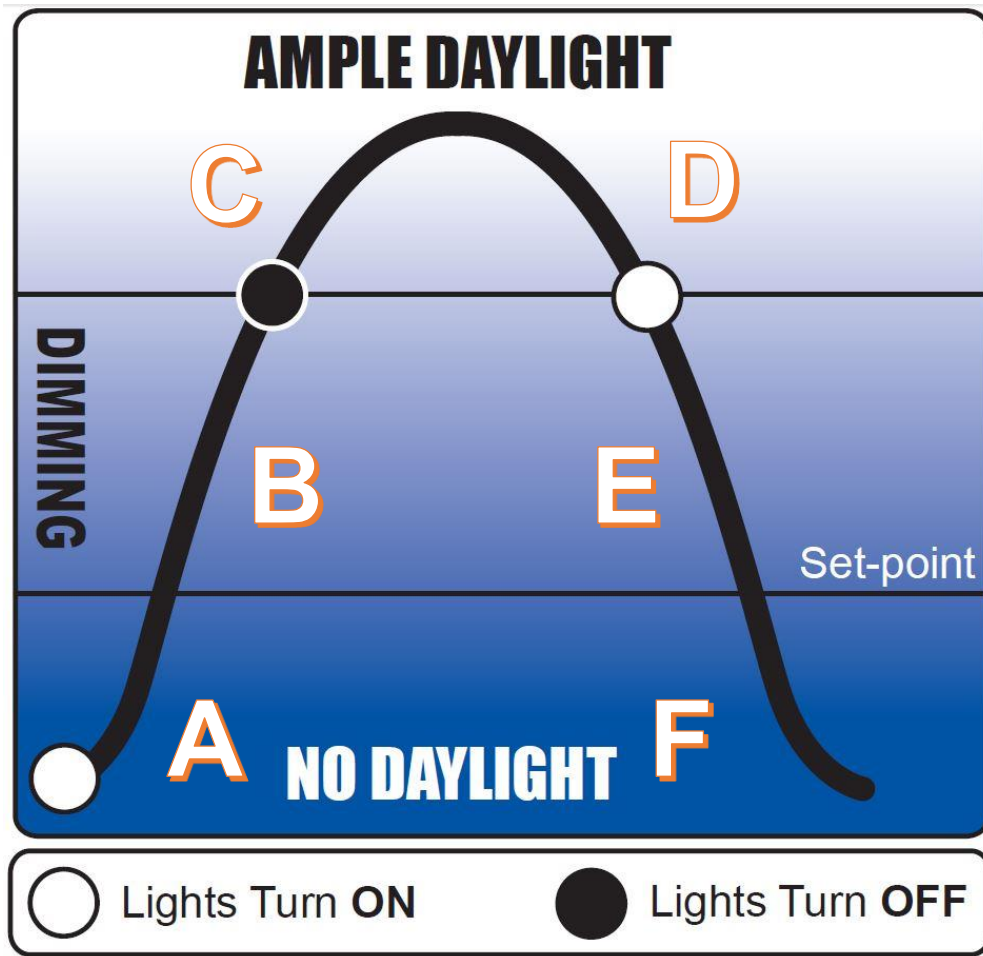

- A. No daylight is available; the dimmable light operates at full bright level (10 VDC).
- B. Increasing daylight begins to contribute to the overall light level; the light is dimmed proportionally.
- C. Sufficient daylight is present to maintain the set-point; the lights are switched off.
- D. Daylight levels drop into the dimming range (deadband); the lights are switched on with the driver set at its full dim level.
- E. Daylight levels continue to drop; the dim level of the driver is reduced proportionally.
- F. Daylight levels fall below the set-point; the driver is back to full bright level (10 VDC)

SENSOR SWITCH DAYLIGHTING CONTROLS

- + PRACTICAL CONTROL SOLUTIONS
 - + Available in stand-alone sensors or incorporated into the occupancy sensor
- + ADVANCED SENSOR INTELLIGENCE
 - + Sensor controls are fully integrated
 - + Integrated foot candle measurement
 - + Automatically adapts to changes in room lighting conditions
- + INSTALLER FRIENDLY
 - + Automatic Set-Point Programming
 - + Calibration can be done at any time of day & under any lighting conditions
 - + Push-button operation



STANDARD SENSOR PRODUCT LINE

SENSOR PRODUCT OFFERING OPTIONS

- + Enclosures
- + Power Type
- + Detection Technology
- + Lens Type
- + Other Options

ENCLOSURES

Stand Alone Devices



Wall Switch
(WS/SS)
Sensor



Ceiling
Mount (CM)
Sensor



Corner/Wall
Mount
(WV, HW)
Sensor



Recessed
Mount (RM)
Sensor

Fixture Integrated



Multi- Lens
(LSXR)



Pole Mount
(SBOR, SBO)
Sensor



Single Lens
(CMxB, HMxB)





Embedded Small Box
(SBR, SB, SBGR, SBG)
Sensor



Embedded Snap-Fit
(SFR, SFOR, SFD, SFOD)
Sensor

POWER TYPE

	Power Type	Ideal Application	Wiring to Sensor	Ease of Installation	Power Pack Needed	Investment \$
	Line Voltage VAC	Small Private Office, High Bay: Single sensor controls circuit	Line voltage wiring	Wall Switch – Easy Ceiling Mount – Moderate Fixture – Retrofittable	No, relay is in the device	Low/moderate
	Low Voltage VDC	Large Office Space: Multiple sensors required	Low voltage wiring	Easy, but requires more devices	Yes	Moderate, more devices
	Wireless (Battery Powered) VDC	Large or Small Office: Multiple or single sensor required	No wiring needed	Super easy	No, relay is in the switch	Moderate, savings on installation

LINE VOLTAGE SENSORS & CONTROLS

- + Integrated Relay
- + Installation to J Box
- + Single Devices

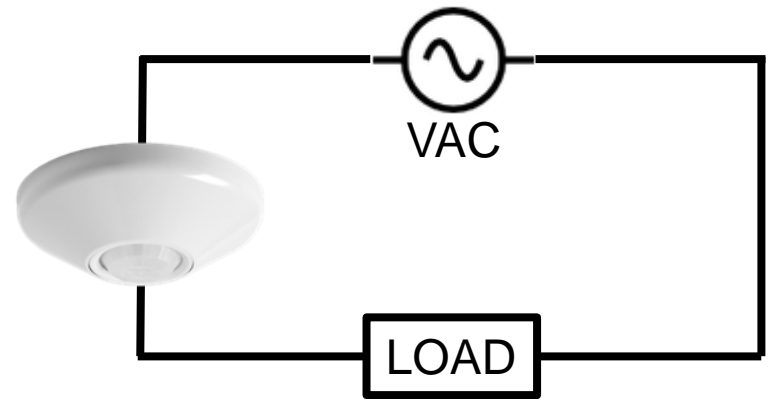

LOW VOLTAGE SENSORS & CONTROLS

- + Power Pack Required
- + Class 2 Wiring
- + Multiple Sensors

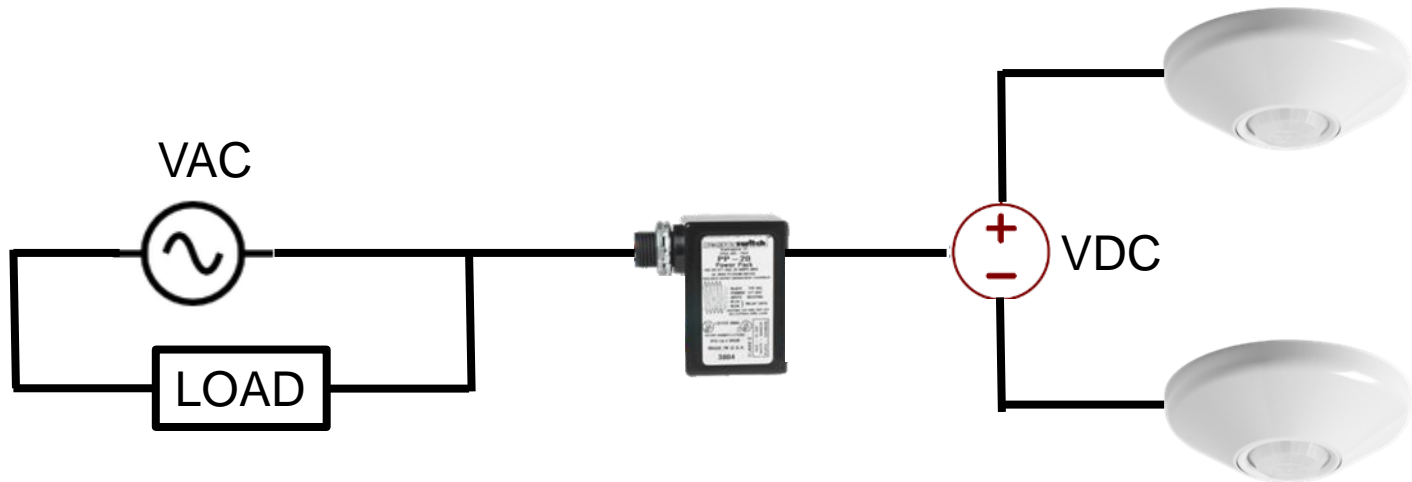

WIRELESS SENSORS & CONTROLS

NEW!

- + ONLY DUAL TECH WIRELESS SENSOR ON THE MARKET!
- + 902 Mhz Wireless Technology
- + Battery Powered (10 year life)
- + Easy Installation
- + Multiple Paired Devices (up to 20)

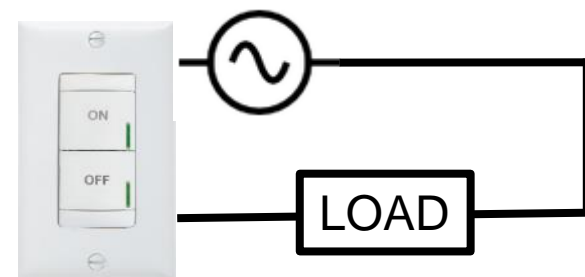
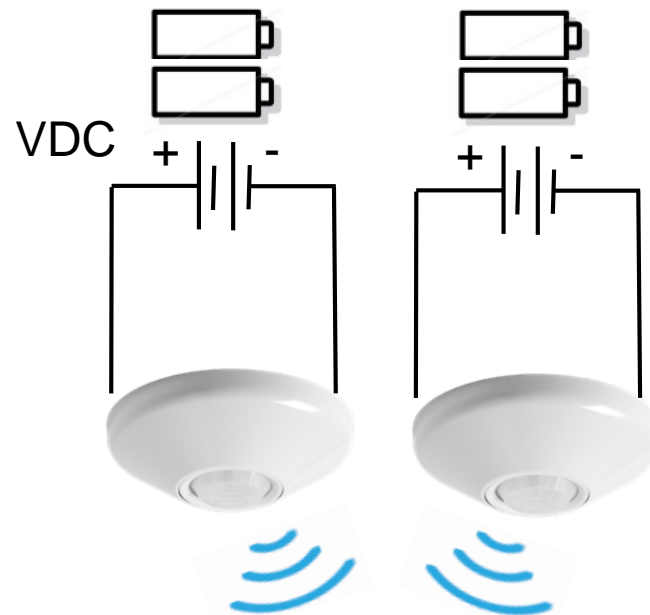

PRODUCT OFFERING BY POWER TYPE



VAC Only



Multi- Lens
(LSXR)



End-of-Aisle, Single
Lens Surface Mount
(HMR)



VAC or VDC



Recessed
Mount (RM,
RMR)



Single Lens
(CMxB, HMxB)



Pole Mount
(SBOR, SBO)



Wall Switch
(WSX/WSD)



Embedded
Snap-Fit
(SFR, SFOR,
SFD, SFOD)



Embedded
Small Box
(SBR, SB,
SBGR, SBG)

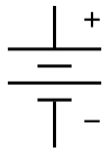

VAC or VDC or BATTERY



Ceiling Mount (CM,
CMR, CM WR)

DETECTION TECHNOLOGY

PIR

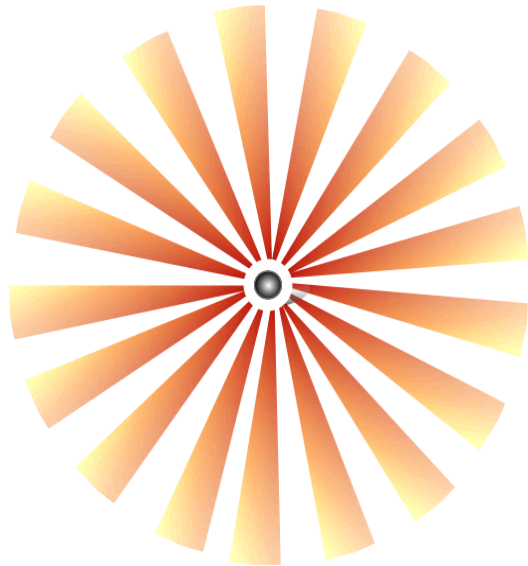

 PIR Detection Segments

Passive Dual Technology
PIR + Microphonics™

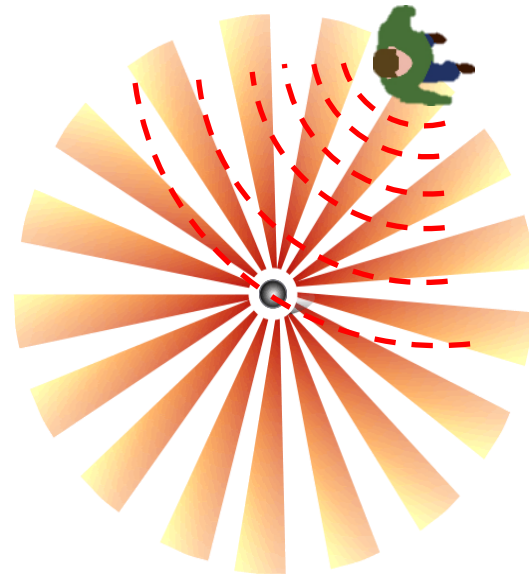

 Sound Wave

- + PIR and PDT Available
- + PDT is a patented Sensor Switch technology

CEILING & FIXTURE MOUNT COVERAGE PATTERNS

SIDE VIEW

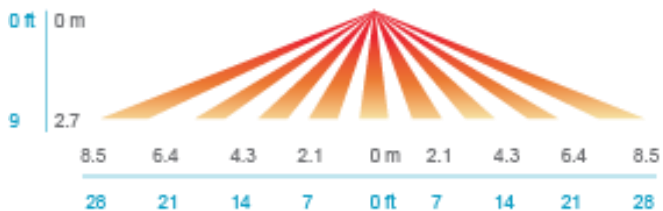

TOP VIEW



Lens 9
Standard Range
360°



Lens 10
Extended Range
360°



Lens 11
Hallway 360°
[CM Only]

CEILING & FIXTURE MOUNT COVERAGE PATTERNS

HIGH VIEW

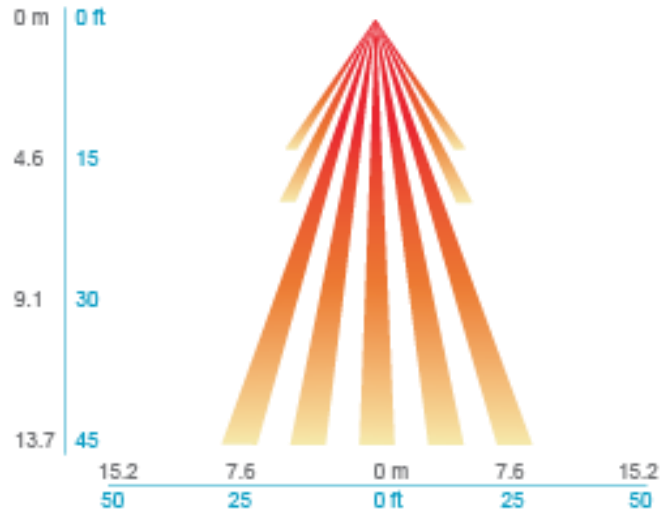

LOW VIEW

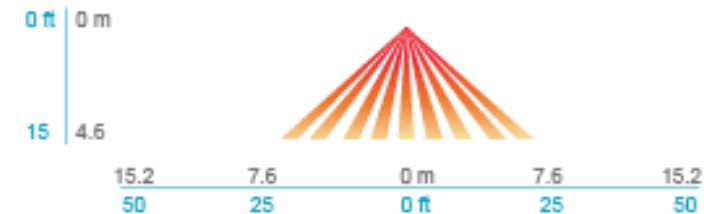

SIDE VIEW

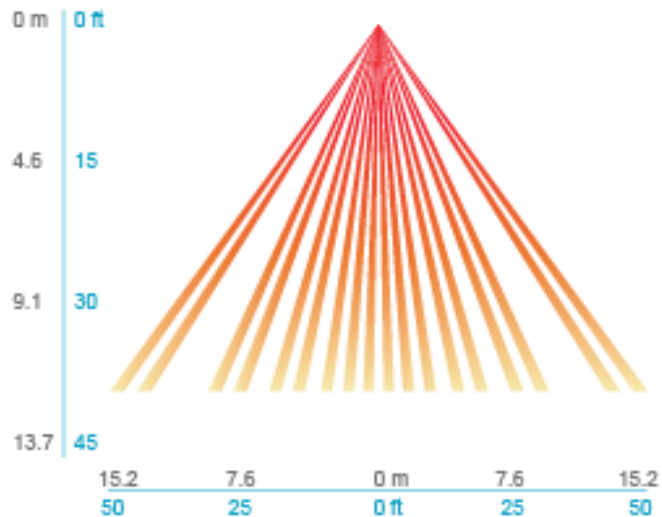

TOP VIEW

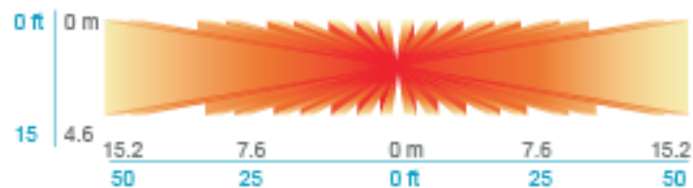

Lens 6
High Mount 360°



Lens 50
High Mount
Aisleway
[Not on CM(R)]

SNAP-FIT & EMBEDDED COVERAGE PATTERNS

9 FT MOUNTING

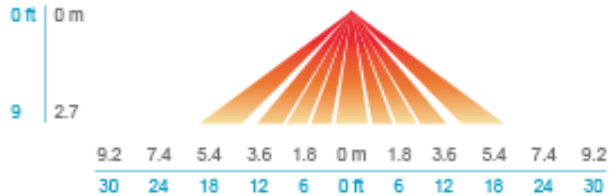

15 FT MOUNTING

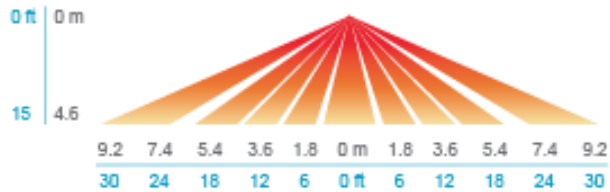

SIDE VIEW

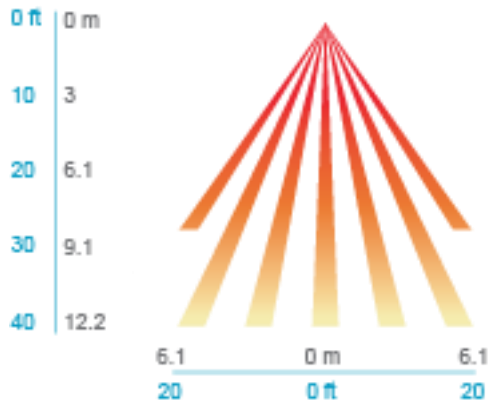

TOP VIEW



Lens 7
Mini Low Bay 360°



Lens 30
Universal 360°

WALL & FIXTURE MOUNT COVERAGE PATTERNS

TOP VIEW

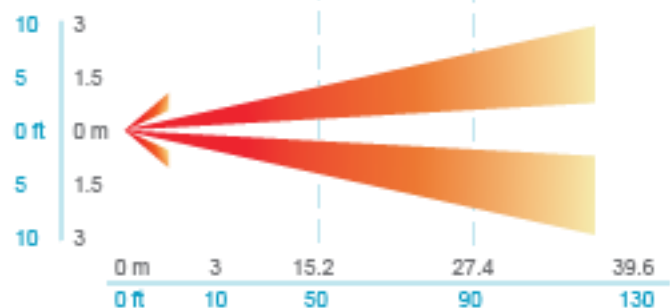

SIDE VIEW - 30 FT MOUNTING

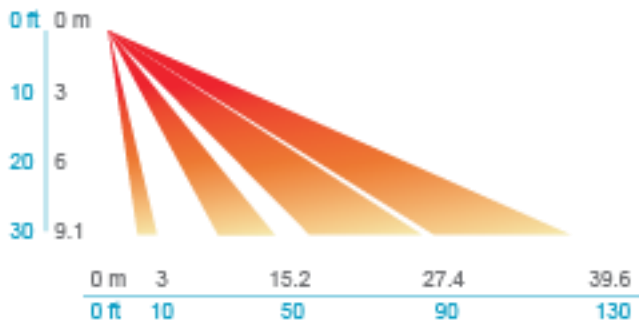

Lens HM 10
High Bay End-Of-Aisle
[HM(R)B 10]

TOP VIEW

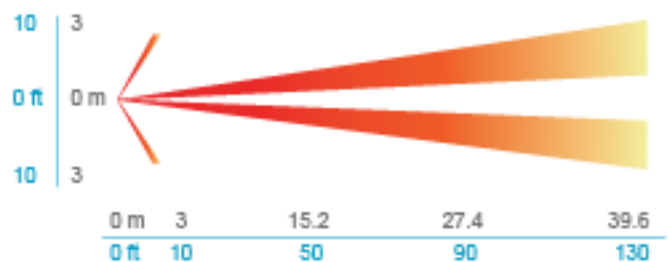

SIDE VIEW - 10 FT MOUNTING

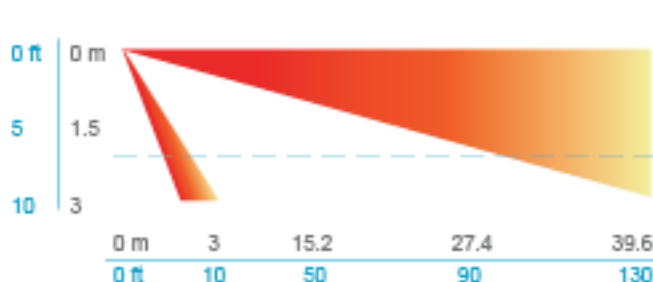

Lens 13
Hallway View
(HW13)

WALL SWITCH COVERAGE PATTERNS

TOP VIEW

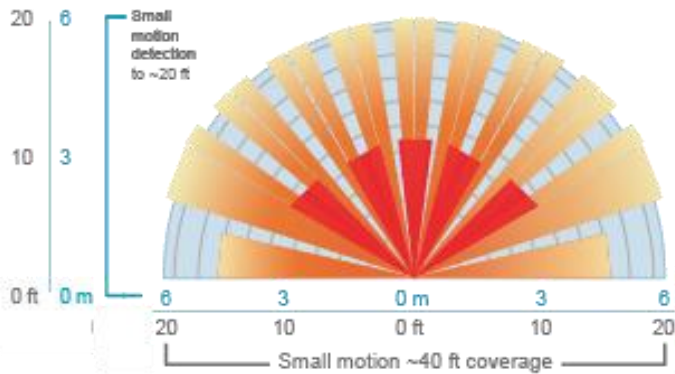

SIDE VIEW

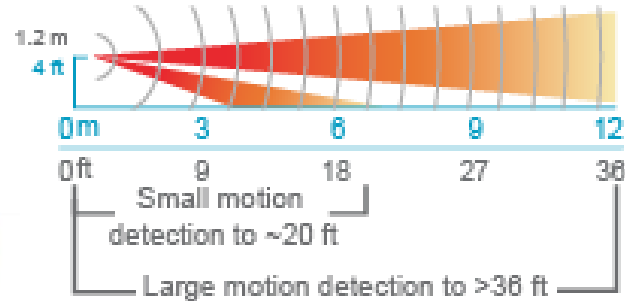

Wall Switch
Decorator Lens
[WSX / WSD]

- Small motion (e.g., hand movements) detection up to 20 ft (6.10 m), ~625 sq. ft
- Large motion (e.g., walking) detection greater than 36 ft (10.97 m), ~2025 sq. ft
- Wall-to-Wall coverage

OTHER OPTIONS

- + Integrated photocell
- + Occupancy controlled dimming
- + Multiple load control (2 pole)
- + Voltage: 120/277VAC or 347 VAC
- + Temp/Humidity: low temp operation to -40° F
- + Color options (white, ivory, gray, light almond, black)
- + Occupancy / vacancy option

ANATOMY OF A MODEL NUMBER



SELLING SENSOR SWITCH

COMPETITORS



WALL SWITCH OCCUPANCY SENSORS: MODELS WSX / WSD / WSX PDT / WSD PDT







Applications include *Private Offices, Rest Rooms, Closets, Copy Rooms and other Small Enclosed Spaces.*

+ Key Features

- + No neutral required
- + Line power and load wires are interchangeable
- + Dual Technology (PDT) utilizes PIR / Microphonics
- + Compatible w/ LEDs, electronic & magnetic ballasts, CFLs, & incandescents



WALL SWITCH OCCUPANCY SENSOR COMPETITIVE COMPARISON

Manufacturer	Sensor Switch		Leviton	Wattstopper	Lutron	Hubbell
Product Image						
Model Number	WSX	WSD	ODS10 & ODS15	PW-xxx	MS-OPS2	AP1277x1
Multi/Dual Technology Option	PIR + Microphonics (WSX PDT)	PIR + Microphonics (WSD PDT)	PIR + Ultrasonic (OSSMT)	PIR + Ultrasonic (DW & DSW-xxx)	PIR + Ultrasonic (MS-A102 & MS-B102)	PIR + Ultrasonic (AD1277x1)
Radial Coverage (ft)						
Small Motion	20	20	15	7.5	20	N/A
Large Motion	40	40	40	15	30	28
Time Delay	30 sec - 30 min	30 sec - 30 min	30 sec - 30 min	5 min - 30 min	1 min - 30 min	4 min - 30 min
Voltage	120/277 VAC	120/277 VAC	120-277 VAC	120/277 VAC	120 VAC	120/277 VAC
347 VAC available	Yes	Yes	Yes - Multi-Tech Only	Yes	No	No
Vandal Resistant Lens	Yes	No	Yes	Yes	No	Yes
Intregated Photocell	Yes	Yes	Yes	No	No	Yes
Neutral Required	Convertible	Convertible	No	No	No	No
Miswire Protection	Yes	Yes	No	No	No	No
Wallplate Included	Yes	Yes	No	No	No	No

CEILING MOUNT SENSORS

MODELS CM 9 / CM 10 / CM PDT 9 / CM PDT 10

Applications for the standard lens include ***Open Offices, Classroom, Restrooms, Large Storage Areas***

+ Key Features

- + Dual Technology (PDT) utilizes PIR / Microphonics
- + Small motion and large motion lens options
- + Integrated photocell option available
- + Compatible w/ LEDs, electronic & magnetic ballasts, CFLs, & incandescents



CEILING MOUNT SENSORS COMPETITIVE COMPARISON

Manufacturer	Sensor Switch	Leviton	Lutron	Wattstopper	Hubbell
Product Image					
Part Number	CM CMR	ODCxx-xDW OSCxx-xOW	LOS-CDT LOS-CUS LOS-CIR	CI-xxx UT-xxx DT-xxx	LVDT LVUS LVPR
Technology	PIR PIR + Microphonics	PIR PIR + Ultrasonic	PIR PIR + Ultrasonic	PIR Ultrasonic PIR + Ultrasonic	PIR Ultrasonic PIR + Ultrasonic
Radial Coverage (ft)	Up to 28 ft	Up to 20 ft	Up to 32 ft	Up to 18 ft	Up to 24 ft
Time Delay	30 sec - 20 min	30 sec - 30 min	8 min - 30 min	5 min - 30 min	30 sec - 30 min
Voltage					
Low Voltage	Yes	Yes	Yes	Yes	Yes
Line Voltage	Yes	Yes	No	Yes	Yes
347 VAC available?	Yes	Yes	No	Yes	Yes
Photocell Option	Yes	Yes	No	Included	Yes
Miswire Protection	Yes; Line Voltage	No	No	No	No
Low Temp Option	Yes	No	No	No	No

WIRELESS OCCUPANCY SENSORS MODELS DENOTED BY WR, I.E. CM 9 WR

Market's Only
Dual Tech
Wireless Sensor

Single room retrofit applications; **Offices, Restrooms, Hallways, Break Rooms** and **Storage Rooms** where wiring to sensor is difficult or impossible

+ Key Features

- + Wireless sensor with a 10 year battery life
- + Dual Technology (PDT) utilizes PIR / Microphonics
- + Line power & load wires are interchangeable
- + Compatible w/ LED, electronic & magnetic ballasts, CFL, & incandescents







WIRELESS OCCUPANCY SENSORS COMPETITIVE COMPARISON – WALL SWITCHES

AcuityControls.
Sensor Switch™
WIRELESS
COMPARISON CHART



		SENSOR SWITCH	LUTRON	LEVITON	HUBBELL
		RDT	Radio Powr Savr	LevNet RF	wiSTAR
WALL SWITCH	Power Supply	Line Powered	Line Powered	Line Powered	Self Powered
	RF Communications	902 MHz	437.0 MHz	315 MHz	902 MHz
	Operational Frequency	50/60 Hz	50/60 Hz	50/60 Hz	NA
	Transmission Range	33-100 ft	60 ft	50 - 100 Ft	80 ft
	Operating Mode	Auto or Manual On	Manual	Vacancy	Manual On
	Operating Temperature Range	14° F to 160° F	32° F to 104° F	32° F to 104° F	32° F to 131° F
	Relative Humidity	20 - 90% non-condensing	0 - 90% non-condensing	0 - 95% non-condensing	5 - 95% non-condensing
	Other features	Silicone Free, RoHS Compliant, 5 color options	Maestro Wireless Switch/ Dimmer, Communicates up to 9 transmitting devices	10 Transmitter IDs	—

WIRELESS OCCUPANCY SENSORS COMPETITIVE COMPARISON – CEILING MOUNTS

		SENSOR SWITCH	LUTRON	LEVITON	HUBBELL
		RDT	Radio Powr Savr	LevNet RF	wiSTAR
CEILING MOUNT OCCUPANCY SENSOR	Sensor				
	Technology	Digital PIR/PDT	PIR	PIR	PIR
	Power Supply	Battery	Battery	Solar Cell or Supplemental Battery	Solar Cell or Supplemental Battery
	RF Communications	902 MHz	437.0 MHz	315 MHz	902 MHz
	Transmission Range	33-100 ft	30-60 ft	up to 100ft	80 ft/ 25 m
	Motion Detection Range	16-36 ft radial coverage	400 sq ft	—	40 ft
	Mounting Height	7-15 ft	9 ft	—	7-10 ft
	Operating Temperature Range	14° F to 122° F	32° F to 104° F	32° F to 104° F	32° F to 104° F
	Viewing Angle	360	360	—	360
	Relative Humidity	20 - 90% non-condensing	—	0 - 95% non-condensing	0 - 95% non-condensing
Other features	Vacancy	Vacancy	—	—	

FIXTURE MOUNT SENSORS MODELS LSXR , CMB

Various lens configurations address applications including *High Bay, Low Bay and Aisleway*

+ Key Features

- + Four interchangeable lenses (LSXR models)
- + Integrated mounting bracket
- + Retrofittable
- + Line power & load wires are interchangeable
- + 0-10 VDC output for dimming



FIXTURE MOUNT SENSORS COMPETITIVE COMPARISON



		SENSOR SWITCH	LEVITON	HUBBELL	WATTSTOPPER
		LSXR	OSFHU	HBA WASP2	HB3x0B-Lx
ELECTRICAL	Voltage	120-277 VAC 347-480 VAC (HVOLT)	120-230-277 VAC 347-480 VAC	120/277 VAC 208/240 VAC 347/480 VAC	120/277 VAC 347/480 VAC
	Load Rating:	800 W @ 120 VAC 1000 W @ 208 VAC 1200 W @ 240 VAC 1200 W @ 277 VAC 1500 W @ 347 VAC 2160 W @ 480 VAC	800 VA @ 120 VAC 1200 VA @ 277 VAC 1500 VA @ 347 VAC 2000 VA @ 480 VAC	800 W @ 120 VAC 1200 W @ 277 VAC 1200 W @ 208/240 VAC 1500 W @ 347 VAC	800 W @ 120 VAC 1200 W @ 277 VAC 1200 W @ 347 VAC 1200 W @ 480 VAC
LENSES	Interchangeable Lenses	Yes	Yes	Yes	Yes
	Lenses Available:	360° High Mount (6); High Mount Aisleway (50); 360° Low Mount Small Motion (9); 360° Low Mount Large Motion (10)	360° High Bay, Aisleway and 360° Low Bay	360° High Bay; Masking Kit for Aisleway	High Bay Aisleway (L1), 360° Low Bay (L3), 360° High Bay (L4)
	Ships with Multiple Lenses	In optional packages: (6); (10); (50); (6, 10); (6, 50); (6, 10, 50)	Yes: High Bay, Low Bay and Aisleway	All Lenses optional: **Lenses sold separately - Not Included with Sensor	No: Only lens specified with Sensor order

FIXTURE MOUNT SENSORS COMPETITIVE COMPARISON



		SENSOR SWITCH	LEVITON	HUBBELL	WATTSTOPPER
		LSXR	OSFHU	HBA WASP2	HB3x0B-Lx
Options / Support	Photocell	Optional: -P option	No	Yes	No
	Dimming	Optional: -HL, -ADC or - ANL option	No	No	No
	Two-Pole Version	Yes	No	Yes	No
	Alternating Relay Option	Yes: 2P AO version	No	Yes: Smart Cycling in 2P versions	No
	Energy/Lamp Saver Mode	Yes, LampMaximizer	No	No	No
	Extender Bracket	integrated and Adjustable	Optional Accessory	Optional Accessory	Optional Accessory
	Low Temp Available	Yes	Yes	Yes, in outdoor version only	No
	Color	White	White	White	White
	Warranty	5 Years	Limited 5 Years	5 Years	5 Years

SENSOR SWITCH ADVANTAGE

- + Energy Savings
- + Reliable Performance
- + Ease of Installation

PERFORMANCE YOU CAN COUNT ON

 **AcuityControls**TM

*Sensor Switch*TM

THANK YOU!