

# CEILING MOUNTED OCCUPANCY SENSOR INSTALLATION GUIDE

The occupancy sensor can be mounted on most ceilings with the provided screws, or mounted on dropped ceilings, using the provided wire bracket.

NOTE: It is often easier to link the sensor before it is mounted on the ceiling. Refer to the "Linking" section.

1. Decide where you want to install the occupancy sensor.  
Tip: For visual alignment, orient the sensor parallel to one of the walls.
2. Remove the mounting plate from the sensor.
3. Decide which of the two installation options is appropriate.

## A. Screw Mounting Plate to the Ceiling

- i. Hold the mounting plate in place on the ceiling and use a pencil to lightly mark two small dots for the screw drill points.
- ii. Drill two holes with a 3/16" drill bit and insert the wall anchors.
- iii. Insert the first screw loosely and level the mounting plate.
- iv. Insert the second screw and then hand-tighten the first screw.

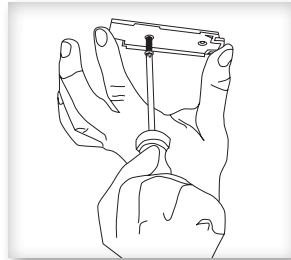

## B. Mount Using the Wire Bracket

- i. Remove the ceiling tile where you want to mount the sensor.
- ii. Place the mounting plate squarely on the ceiling tile and use the wire to mark two points for the holes.
- iii. Punch two small holes through the ceiling tile at the marked points.
- iv. Insert the wire bracket through the two holes in the mounting plate.

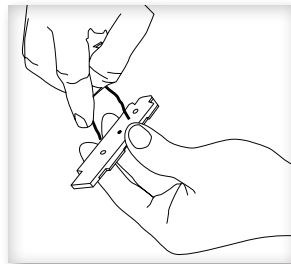

Make sure the ends are roughly even.

- v. Feed the wires through the holes in the ceiling tile.

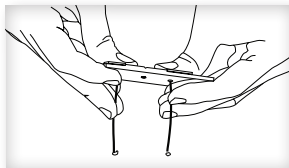

- vi. On the front of the ceiling tile, flatten the wire bracket so it is snug against the mounting plate.

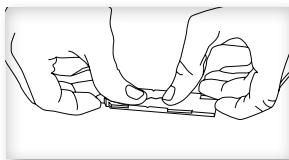

- vii. On the back of the ceiling tile, twist the wires together to hold the mounting plate securely.

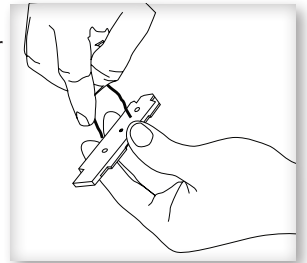

- viii. Replace the ceiling tile.

4. Attach the sensor to the mounting plate.  
With the 2-button interface facing you, slide the sensor to the left on the mounting plate until it snaps into place.

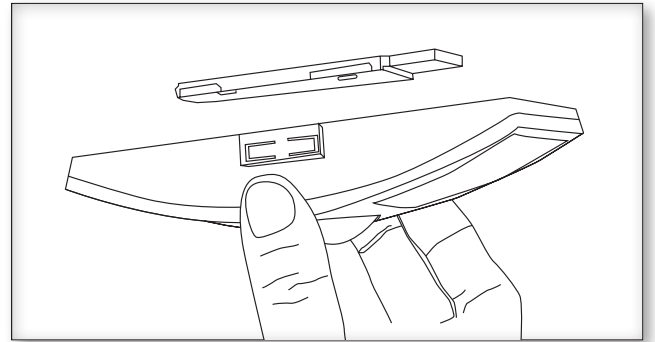

5. Confirm the sensor is properly positioned to detect motion and has sufficient light to operate - refer to the "Walk Test" and "Light Test" sections.

## Supplemental Power (optional)

In areas with consistently low lighting, or prolonged periods of darkness, battery power (CR2032) or an auxiliary 3-5 VDC power source can be used to supplement the solar energy harvester.

1. Remove the sensor from the mounting plate and identify the battery holder and auxiliary power connector on the circuit board

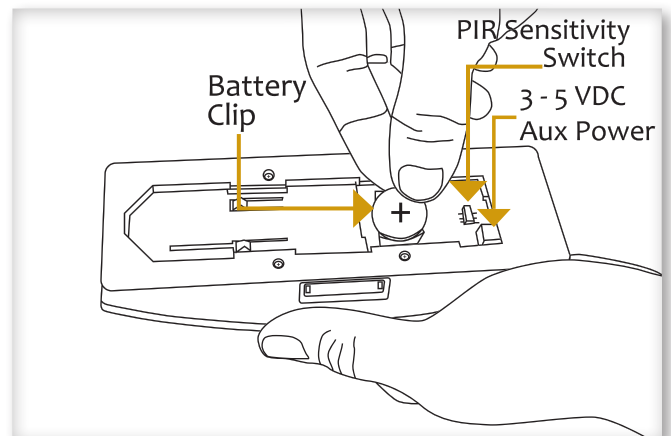

2. A. Insert the battery under the clip with the positive pole (+) up and press it in place
3. B. Or insert the 3-5 VDC + and - leads into the appropriate screw terminals.
4. Remount the sensor on the mounting plate.

# CEILING MOUNTED OCCUPANCY SENSOR INSTALLATION GUIDE

## PAIR & PLAY TECHNOLOGY

STEP 1: Enter pairing mode. Double tap the xCella Remote Module user button to enter Override mode, then double tap again to enter Pairing mode. The Remote Module LED will blink rapidly.

Remote Module  
user button



Normal  
LED: 1/2 second blink

Double tap

Override  
LED: 2 second blink

Double tap

Pairing  
LED: 1/4 second blink

### Notes:

- The relay blinks once after each pairing and twice after unpairing.
- The Module stays in pairing mode for 30 seconds after each pairing is complete.

STEP 2: Send sensor pairing commands by pressing the menu (non-indented) button once<sup>1</sup>. The Remote Module's relay will cycle once (light fixtures blink) each time a switch or sensor is successfully paired.



Press Menu (non-indented)  
button once

Sending the pairing command a second time will unpair the switch from the Remote Module. The relay will cycle twice after a sensor or switch is unpaired.

STEP 3: Return to normal mode by double tapping the xCella Remote Module button once.

### NOTES:

1. Up to 16 total switches and sensors can be paired to an xCella Remote Module.