

# Installation & Operation

# GR 2400

Manual



LIGHTING CONTROLS

[www.lightingcontrols.com](http://www.lightingcontrols.com)

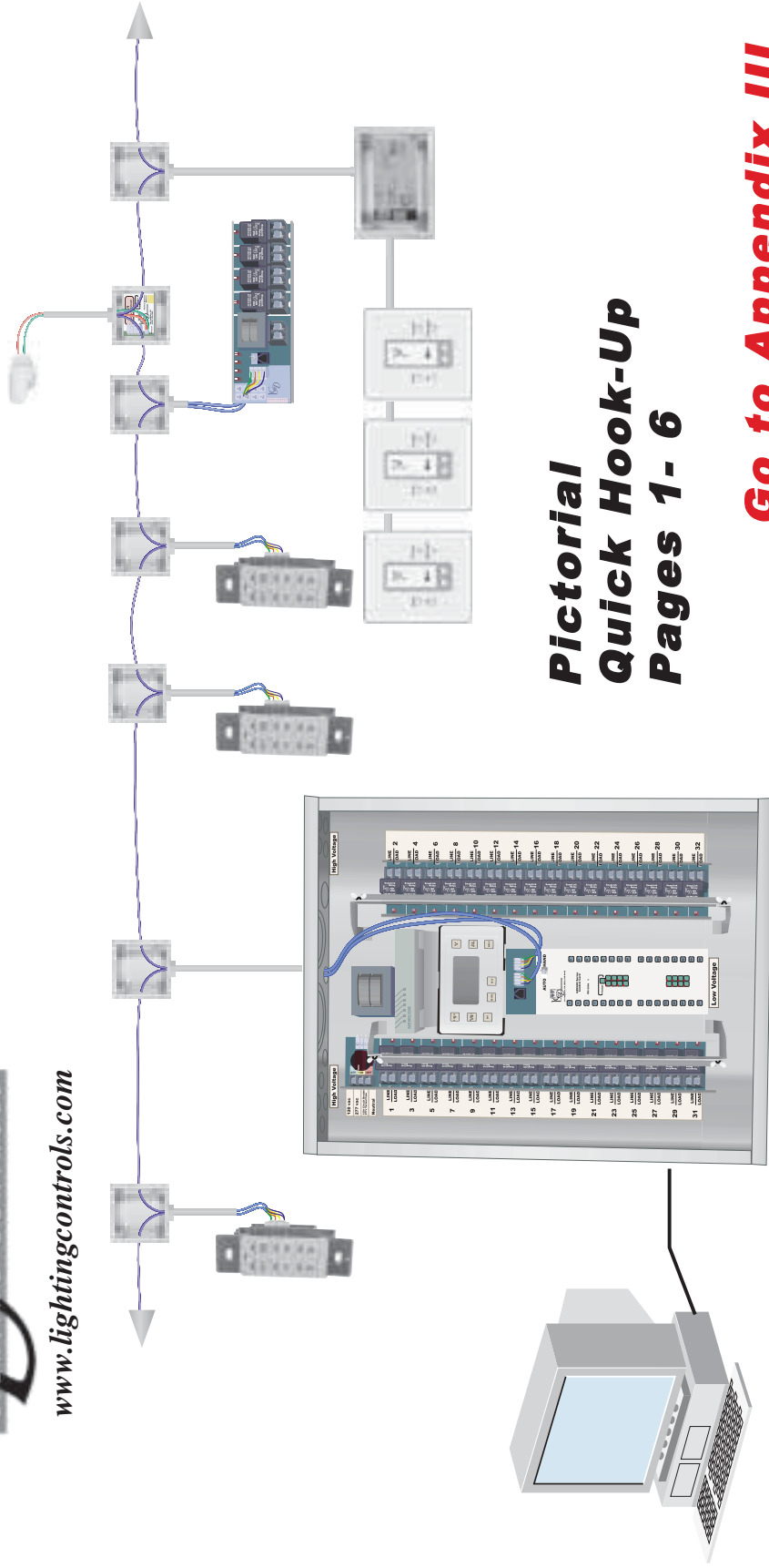

**Pictorial  
Quick Hook-Up  
Pages 1- 6**

**Go to Appendix III  
For Final Check Out  
Page 66**



# The GR 2400 Manual Index

Quick Start Instructions	Page 2
Hooking up the GR 2400 System	Page 3
One Line Diagram	Page 3
Telephone Connection	Page 4
Typical Panel Schedule	Page 5
Wire Labeling & Phone Hook Up	Page 6
Connect & Terminate Bus	
<b>GR 2400 System in a bit more detail</b>	
Typical Hook Up 2 Panels 2 Switches	Page 8
Long Distances between Switches	Page 8
Single panel Lots of Switches	Page 8
<b>Too Many Switches on section of Bus</b>	<b>Page 9</b>
Things to Know about the bus	Page 10
Too Long a Bus	Page 11
<b>Parts of the System</b>	
Relay (Types of)	Page 12
Changing Relays	Page 13
Dual Voltage Input Card	Page 14
DigiLink	Page 14
GR 2404	Page 16
GR 1416,2432 & 2448 cards	Page 18
Board Addressing	Page 18
Modes	Page 18
8 & 16 Zone and Discrete Mode	Page 19
GR 2416 Card	Page 20
Checking the Mode	Page 21
Assigning Relays to a Zone	Page 21
Viewing which relays are in a zone	Page 22
Sequence Speed	Page 22
Flashing LEDs What they mean	Page 23
Other Accessory Boards	Page 24

## Programming the GR 2400 System

Picture of Programmer	Page 25
Navigating the Clock	Page 26
The USER Menu	Page 27
Review/Changing a Schedule	Page 27
Mon to Fri Schedule	Page 28
By Day Schedule	Page 28
After Midnight	Page 29
Schedules and Groups	Page 30
Disabling a Schedule	Page 30
Programming a Group	Page 30
Group Properties	Page 31
When to Set the Blink Warning	Page 32
Manual Override Menu	Page 32
Setup Menu	Page 32
Contacting LC&D	Page 33
Restricted Menu	Page 33
System Setup Menu	Page 33
Set Time & Date	Page 33
Edit Holidays	Page 33
System Option	Page 35
Keyboard Lock Code	Page 35
Select Location	Page 35
Display Options	Page 36
Naming Menu	Page 36
What and When Menu	Page 37
Scheduled Events	Page 37
What Controls Groups	Page 38
What Controls Relays	Page 38
Relay Properties Menu	Page 38
Changing the Time Delay between relays	Page 38
Specifying Normally Closed Relays	Page 39
Sentry Switch Option	Page 40
Other individual Relay Parameters	Page 40

# The GR 2400 Manual Index (Cont)

Addressing Bus Scan	Page 40
Auto Addressing	Page 41
Read Address	Page 41
Bus Diagnosis	Page 41
Group Loads Menu	Page 42
ON/OFFSequencing	Page 42
Programming a Sequence	Page 43
Programming Switches	Page 43
Programming Buttons	Page 43
Coying a Switch	Page 44
Additional Features in Clock version 4.16	Page 45

## **Photocell Control Cards**

Single Input Card	Page 50
Three Input Card	Page 51
Programming Photocells	Page 51
Daylight Harvesting	Page 52
Special Situations	Page 52

## **Appendix I: The Restricted Menu**

The Restricted Menu	Page 53
Factory Set Up Menu	Page 53
Addressing Bus Scan	Page 53
Error Statistics	Page 53
Panel Switch Types	Page 54
Relay Properties	Page 54
Remote System Menu	Page 54
Remote Password	Page 54
Dial Up Host	Page 55
Owner Settings Menu	Page 55
Erase Options Menu	Page 55
Erase Clock Memory	Page 56
Changing the Mode on a GR 2416 Card	Page 57

## **Appendix II: Start up Check List.**

Pages 58 through 62

Specifications

Page 63

# GR 2400 MANUAL

How to install the Lighting Control & Design GR 2400 System

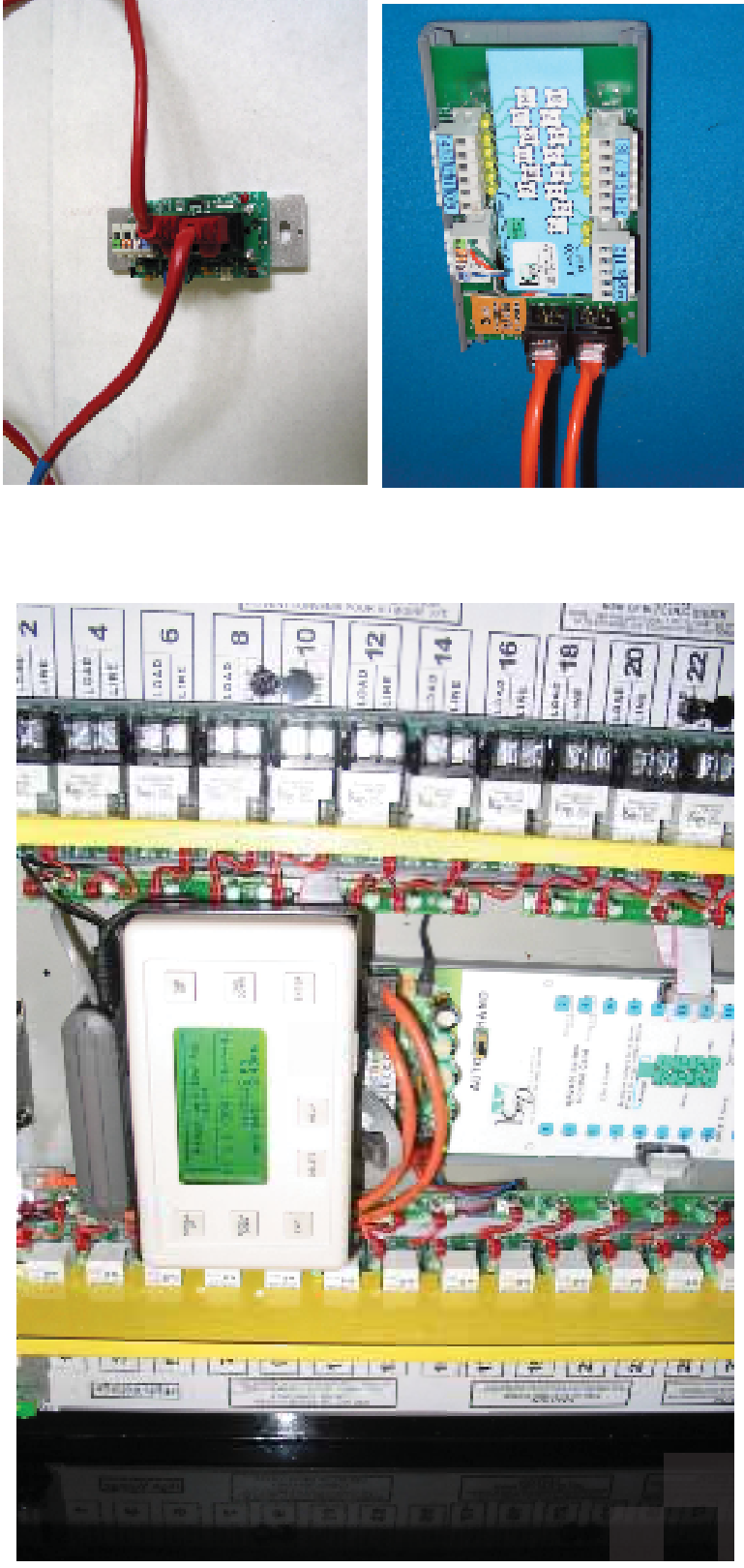

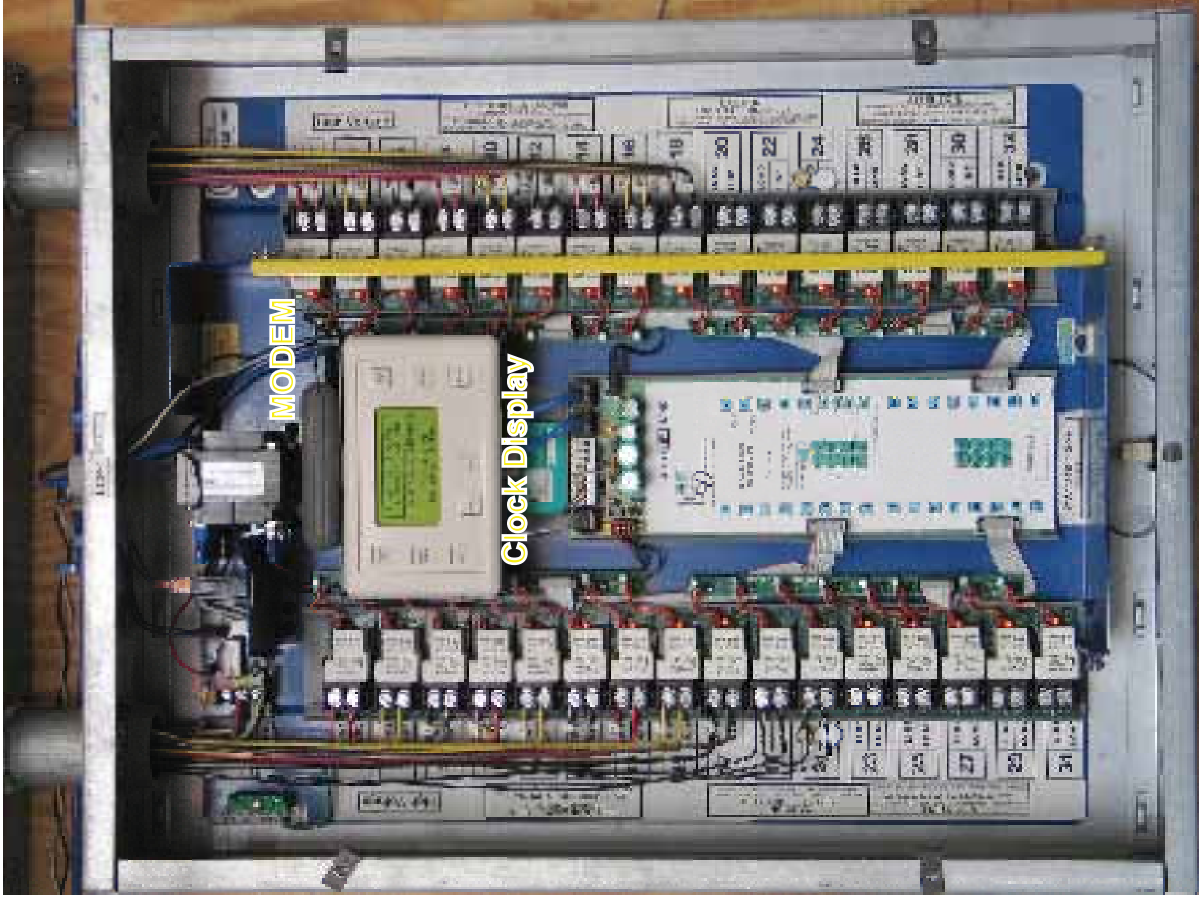

**GR 2432 Relay Panel with 32 Relays Rated at 20 amps 277 Vac  
Left barrier removed to show complete relay.**



**Chelsea 6 Digital Switch**



**Outdoor PhotoCell**

## **Quick Start Instructions** **Hooking up the GR 2400 System**

The GR 2400 system is very simple to put together.

The basic system consists of:

- 1) The Master Panel like the one on the left, it will have a Clock Display and usually a modem.
- 2) A Switch or Switches like the Chelsea switch shown above.
- 3) Sometimes there will be a PhotoCell.
- 4) Sometimes there will be additional slave relay panels. They do not have the clock display or the modem in them.
- 5) Sometimes there will also be other accessories. These are discussed later in the manual.

All these items are hooked together on a digital bus of Category 5, four twisted pair data cable.

### Typical Hook Up

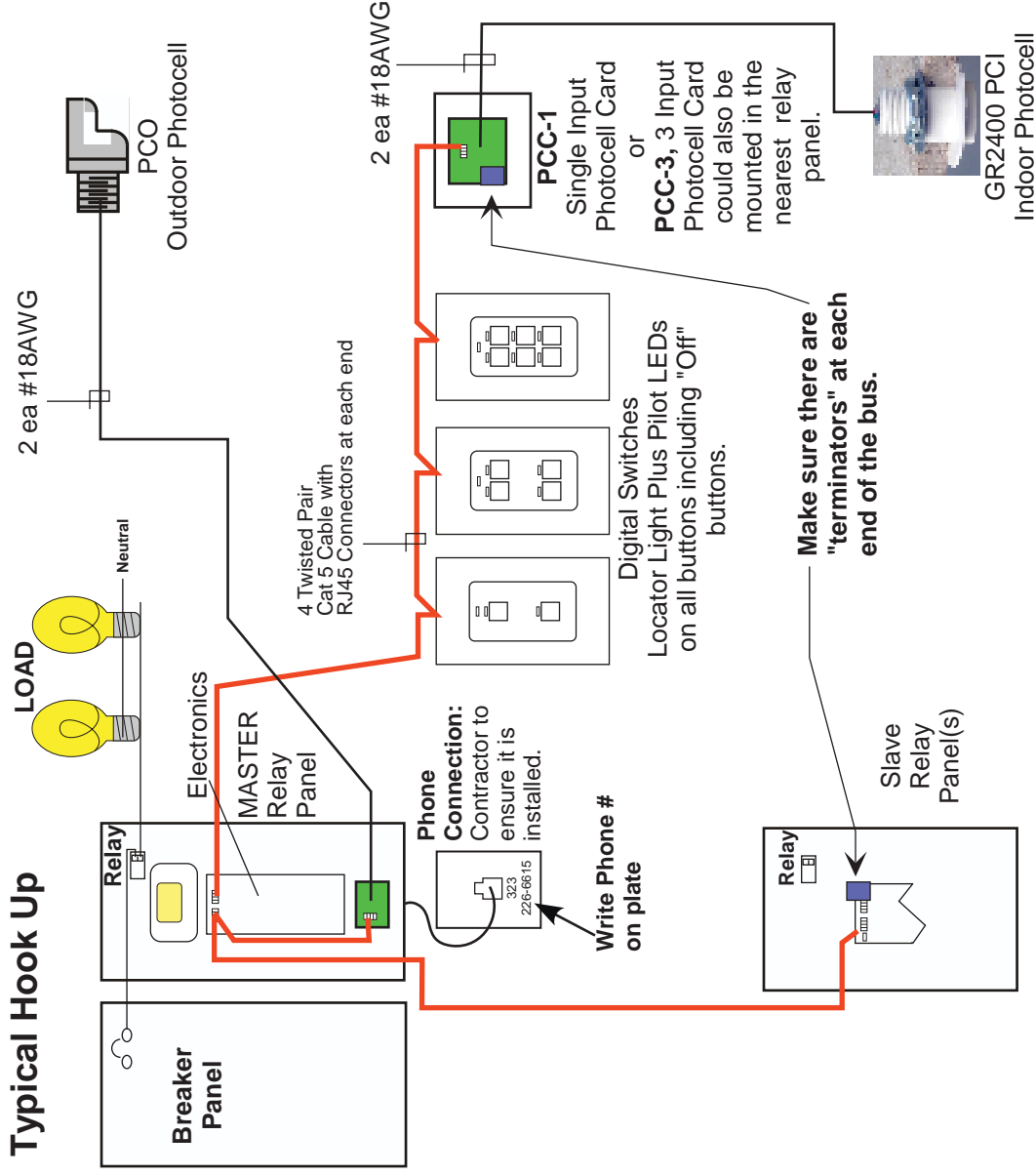

### One Line Diagram

This one line diagram shows what types of low voltage wires are used to connect the parts of the system together.

The Cat 5 cable must be looped through each item on the bus with NO SPURS!

The items on the bus (switches, panels, photocell cards, etc.) may be arranged on the bus in any order, its not important. The only point to be careful of in large systems is getting enough voltage to the switches. There are several pages of the manual that cover this point later.

### Telephone Connection

LC & D systems come pre programmed from the factory with the data on hand when we ship it. However at start up there are usually some minor changes and some trouble shooting to be done. If the telephone hook up is available a factory tech can check out the system rapidly over the phone. Not having the phone line in can slow project completion.

**PLAN AHEAD! Get the phone line installed in time for start up! Call LC & D before installation for quick tips. Call LC & D again before start up for help with final programming. (800) 345-4448.**



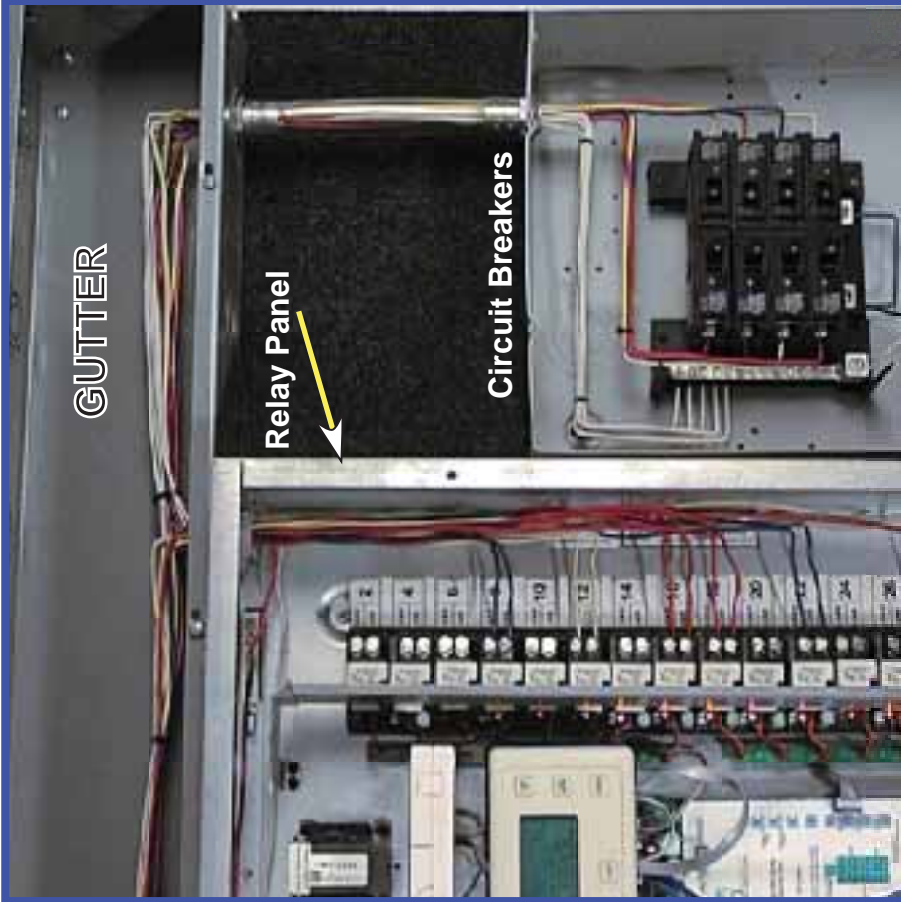

## Typical Connection

Most jobs are pre programmed at the factory. You must land the wires from the breakers to the designated relays and connect them to the correct loads for the programming to work!

Note: If you use a gutter the neutrals do not need to be sent through or landed in the panel.

The panel schedules should be at the beginning of this manual and also in a pocket on the door of each panel.

Please follow the panel schedule and you will save everyone a lot of work.

## Typical Panel Schedule

Relay	Zone	Line Feed	Type	Units	Load Description
R1		HPBA 1	BC	120	0500 EBH - FAUSEVA
R2		HPBA 3	BC	120	0500 EBH - FAUSEVA
R3		HPBA 5	BC	120	0500 EBH - FAUSEVA
R7		HPBA 7	BC	120	FRONT EXT- EBH
R8		HPBA 9	BC	120	FRONT EXT- EBH
R11		HPBA 11	BC	120	FRONT EXT- EBH
R13		HPBA 13	BC	120	FRONT EXT- EBH
R4		HPBA 4	BC	120	0500 EBH - FAUSEVA
R6		HPBA 6	BC	120	0500 EBH - FAUSEVA
R9		HPBA 8	BC	120	0500 EBH - FAUSEVA
R10		HPBA 10	BC	120	0500 EBH - FAUSEVA
R12		HPBA 12	BC	120	0500 EBH - FAUSEVA
R14		HPBA 14	BC	120	REAR LTB- EBH

Relay	Zone	Line Feed	Type	Units	Load Description
R5		HPBA 2	BC	120	0500 EBH - FAUSEVA

Medium	Relay	Units	Load Description
Relay	R1	120	0500 EBH - FAUSEVA
Relay	R2	120	0500 EBH - FAUSEVA
Relay	R3	120	0500 EBH - FAUSEVA
Relay	R7	120	FRONT EXT- EBH
Relay	R8	120	FRONT EXT- EBH
Relay	R11	120	FRONT EXT- EBH
Relay	R13	120	FRONT EXT- EBH

  

Active Relays	BC	48
4	1200	0
0	1200	0
0	0000	0

This Job  
 CENTER DRIVE, LA  
 LOCATION: B, RM 178  
 HPBA/HPBC  
 ADDRESS 1-12  
 LCP-2  
 (LCHB)



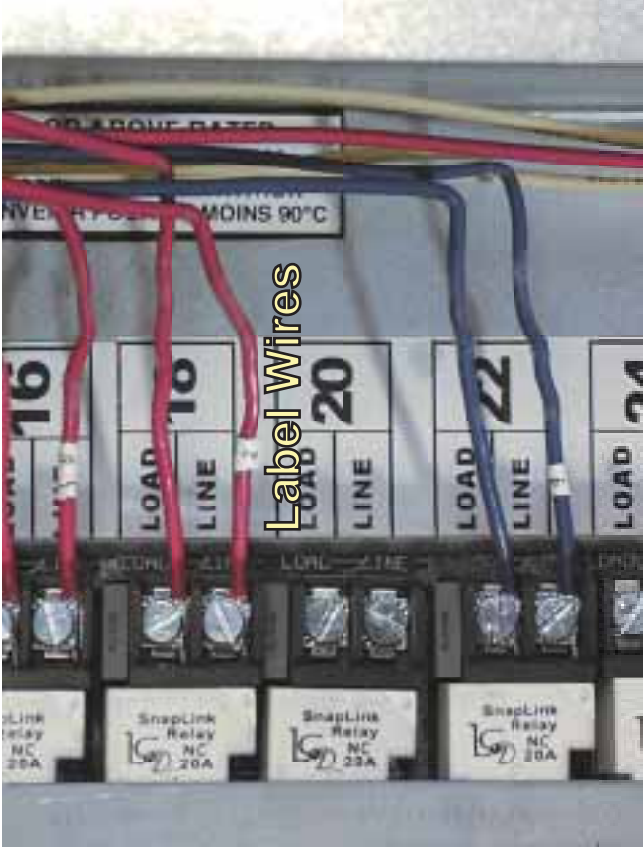

Label Wires



Connect Phone Line

Write Phone # on Phone Plate

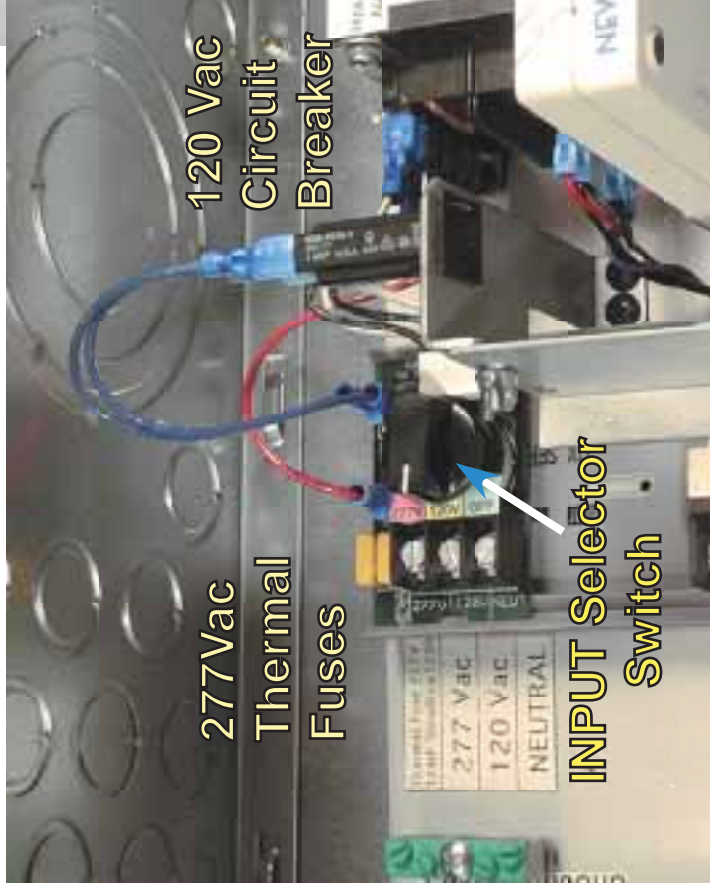

120 Vac Circuit Breaker

277Vac Thermal Fuses

INPUT Selector Switch

Label the line feed wire with the number of the breaker.

Use a separate breaker for powering the electronics. This prevents a problem circuit from disabling the whole system.

Note that the 120 Vac feed is protected by a circuit breaker mounted to be accessible when the door is on the panel while the 277VAC feed is protected by self resetting thermal fuses. The rotary switch also has a position for OFF if the system needs to be de-powered.

Did we mention it is a good idea to get the phone line installed early! It may not get used much so it could be placed in parallel with a fax machine and plugged in as necessary.

### Connect and Terminate the Bus

The "Bus Connectors" are all wired in parallel. Use Cat 5, 4 twisted pair wire.

- 1= (Nominal Ground or Common of System) The Green Pair wired together
- 2= (Data Wire "A") The Orange wire of the Orange White Pair
- 3= (Data Wire "B") The White wire of the Orange White Pair
- 4= (+12 Volt dc to power switches) The Blue White Pair wired together.

Note: In earlier manuals a different color code was used. If adding to an older system make sure your color code is exactly the same as the old system.

On panel control cards there are two connectors. These are in parallel. It is a good idea to have one cable come in and one out so that the bus can be "opened" for trouble shooting.

**Make sure the numbered switches are connected at the correct locations as per the switch schedules or the programming will be incorrect.**

Back View of a Digital Switch Showing the Bus Connector Hook up.

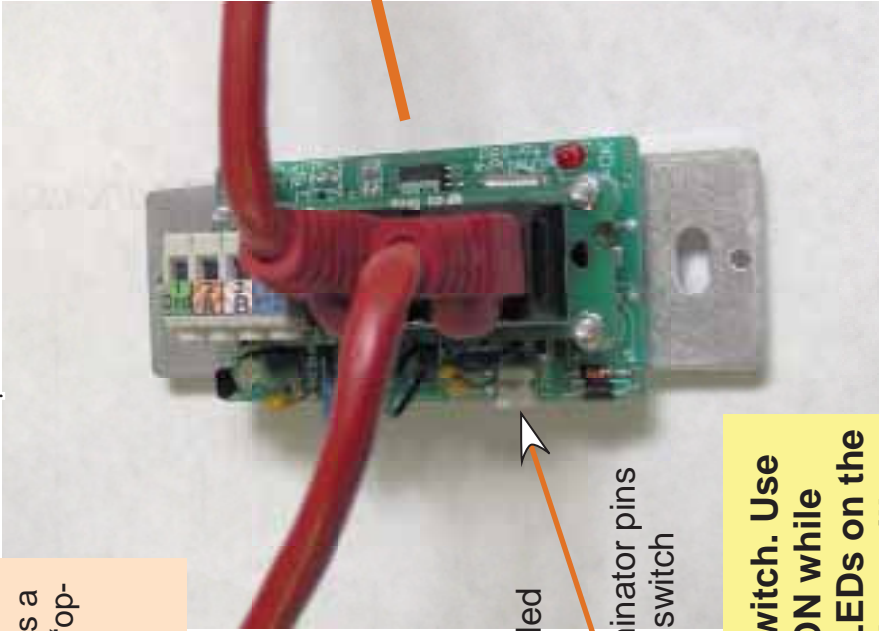

Cat 5 Cable



Blue End of bus Terminator Installed

Location of Terminator pins on the back of a switch

**Note the HAND/AUTO switch. Use this to keep the relays ON while testing the system. All LEDs on the control cards and switches will still indicate even with the relays locked ON.**

Close Up of a Relay Panel control card showing the four Bus Connectors. Two RJ 45s and two 1-2-3-4 connectors.



### Connecting up the GR 2400 System.

Lighting Control & Design recommends the use of pre-made and pre-tested Ethernet style cables. These can even be pulled through conduit with little difficulty. In most cases the cabling does not have to be in conduit though plenum rated cable may be required.

The Wiring diagram shown is from [www.lanshack.com](http://www.lanshack.com). They are also a good supply house for off the shelf pre-made and tested cables at a cost that is way less than one can make them oneself.

Wiring Scheme 568B

Pair #	Wire	Pin #
1-	White/Blue	5
	Blue/White	4
2-	White/Green	3
	Green/White	6
3-	White/Orange	1
	Orange/White	2
4-	White/Brown	7
	Brown/White	8

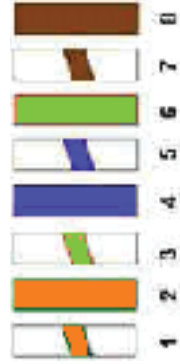

While the wiring scheme above is the most commonly used wiring some jobs may have a standard that more closely follows Telephone company conventions Data hook up of 568A. (which transposes the Green and Orange pairs) This can also be used as long as both ends of the cable are **ALWAYS** the same.

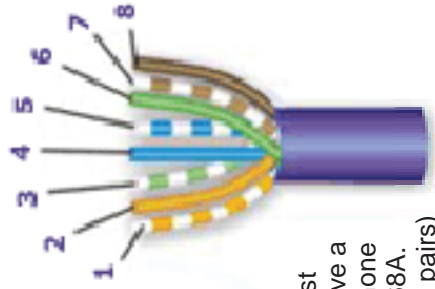
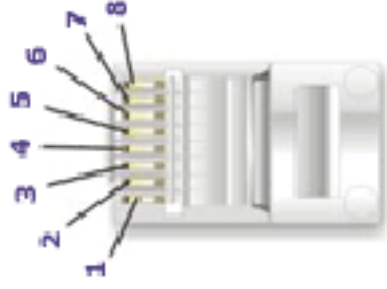

**Cable tester and crimping kit available from LC & D**

Note: The cable tester will **NOT** work if any of the wires are plugged into any card since 3 of the wires are shorted together to carry 12 volts and 3 are shorted to carry ground.

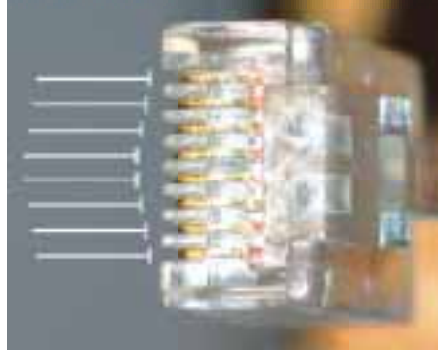

### Cable Testers

A vital tool to have is a cable tester. This ensures that cables are verified in the field as being hooked up correctly. (90% of field problems are caused by incorrectly installed cables.) If each cable is tested just before plugging it in these problems go away. The cable tester and crimping kit is available from LC & D at cost. Call 800 345 4448 and ask for Tech support.

Inspect your crimps! A damaged or Old crimper will not seat each of the contacts evenly. Though the cable may pass the tester any tugging or mechanical stress can cause problems later.

**Typical Hook up of a 2 Panel system with two Switches using**

**“1234” Connectors:**

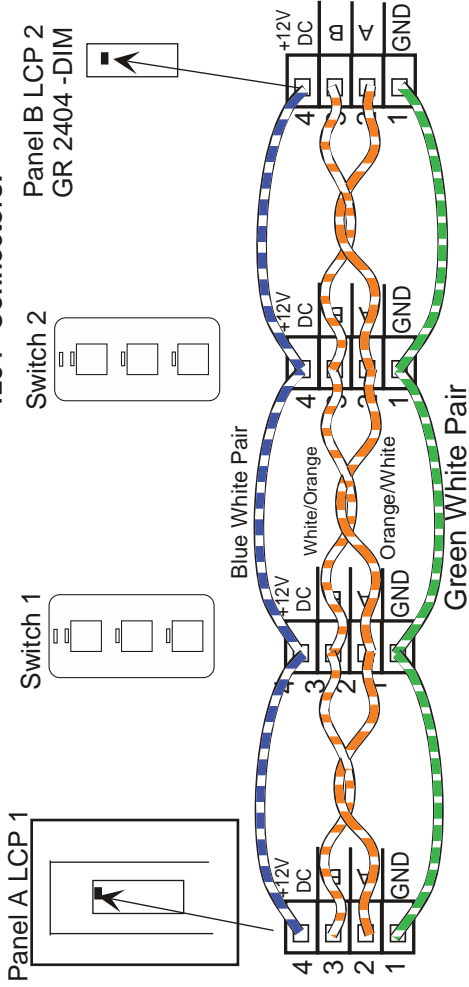

**Using the “1234” Connectors**

Older systems have “1234” Connectors. These are wired as shown on the left. New systems use RJ 45 connectors only and the “1234” connectors are being phased out. Note that the 1234 connectors use the Orange pair as the Data pair while the RJ45s use the Blue pair as the data pair. Should there be a situation that needs a 1234 at one end and an RJ 45 at the other make sure the connection is carefully checked before it is connected.

**Switches with Long Distances Between Them and Multiple Switches with only One Panel.**

Cat 5 cable is 24 AWG and will carry 1 amp of current over 200 ft. After that the resistance of the wire becomes too great and there will not be enough voltage to run the electronics of the switches.

A system with a lot of switches or long distances between the panel and the switches may require additional wire to handle the voltage drop.

The calculations for this are a bit tricky and it is always better to be safe than sorry. Here are some rules of thumb.

Each Switch takes about 100ma of current. Thus 10 switches equals about 1 amp. Cat 5 wire with RJ45s used three conductors for the power which averages out to about 1 ohm per 100ft. Per Ohms LAW  $V=IR$  ,  $I=1$ amp  $R =2$  Ohms so Voltage drop will be 2 Volts)

There is also a limit to the amount of current a panel can provide to drive switches.

**Panel A LCP 1**

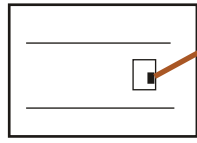

Single Panel with 10 switches will be OK with a wire length of up to 200ft.

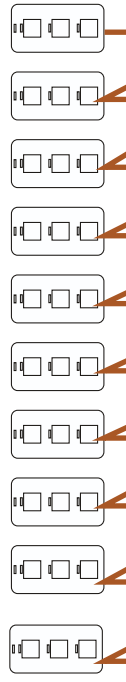

**Panel A LCP 1**

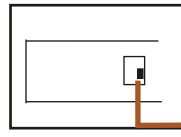

Each 48 relay panel can drive 12 switches. For each relay not being driven an extra switch can be added up to a maximum of 20. Thus a 32 relay panel can have up to 20 switches. A panel at each end of the line is better than having two panels at the beginning of the line to drive all the switches.

**Panel B LCP 2**  
A panel at each end of the run increases the number of switches and length of wire.

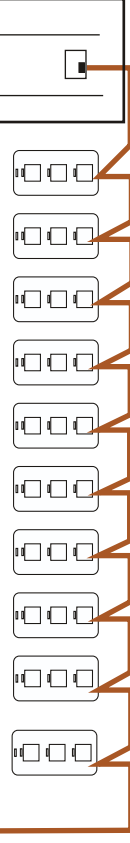

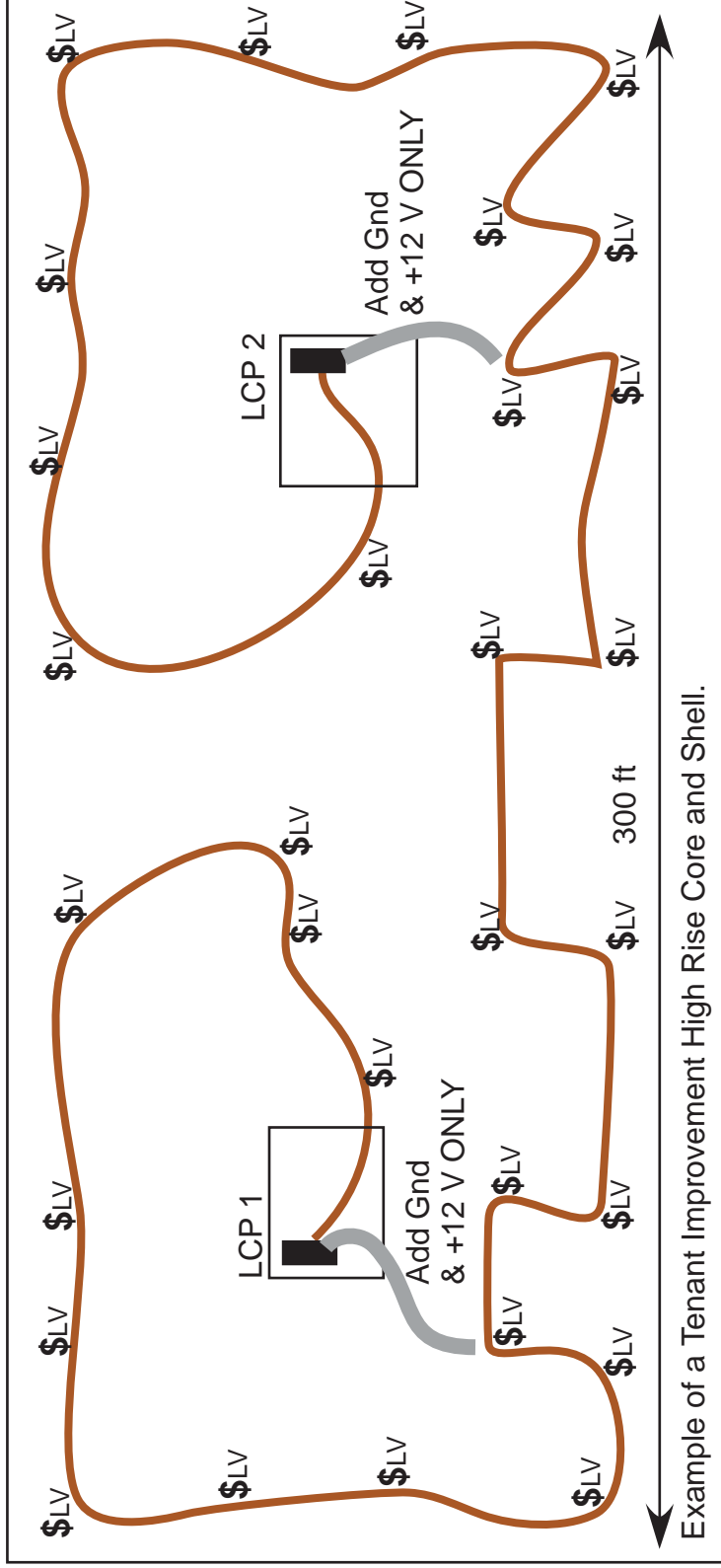

Example of a Tenant Improvement High Rise Core and Shell.

**Getting out of trouble  
Too Many Switches on a section of Bus**

In this example the cat 5 Bus was wired before the equipment and the manual were received. Though the electrician knew what to do from a previous job he did not have this number of switches on that job so had not run into this problem before.

By adding two sections of booster wire to boost the Ground and +12 Volt connection he fixed his problem with voltage drop to the switches.

The booster wire can be 2 number 18s or just a short section of Cat 5 with two pairs twisted together for +12 and two pairs twisted together for Gnd.

Another solution is to get a "BUS BOOSTER" from LC & D which is just a 12 volt power supply with RJ45 connectors on it used to boost the voltage in the middle of the bus.

Also note: Never connect the bus "ground" to the actual "Earth" ground. It is supposed to be a "floating" ground.

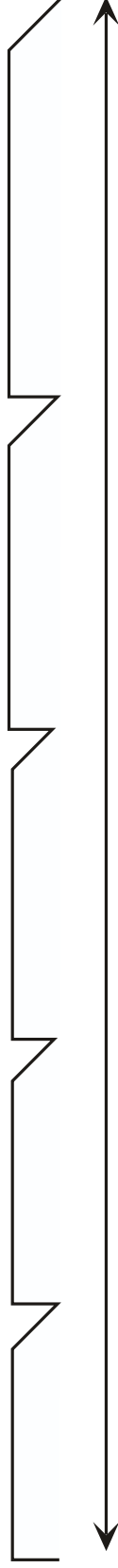

## Things to know about the BUS 4000 ft

The bus may be up to 4000 ft long. Items must be connected in sequence. No Star Topologies allowed.

Note the way the bus has been drawn with an angle in and vertical out. This is the standard way to represent an RS 485 type data bus.

RS 485 is a Standard that describes the voltages associated with transmitting data on this type of bus.

**NEVER run the bus close to current carrying conductors even if they are in conduit. 2ft away is good. NEVER EVER run the bus in the same conduit as high voltage wires.(Even in cases where it is allowed by code.) In places with a very high Radio Frequency Field (ie near a Radio Station Antenna and sometimes even high frequency ballasts can cause a problem) it may be necessary to use a shielded Cat 5 or run it in conduit.**

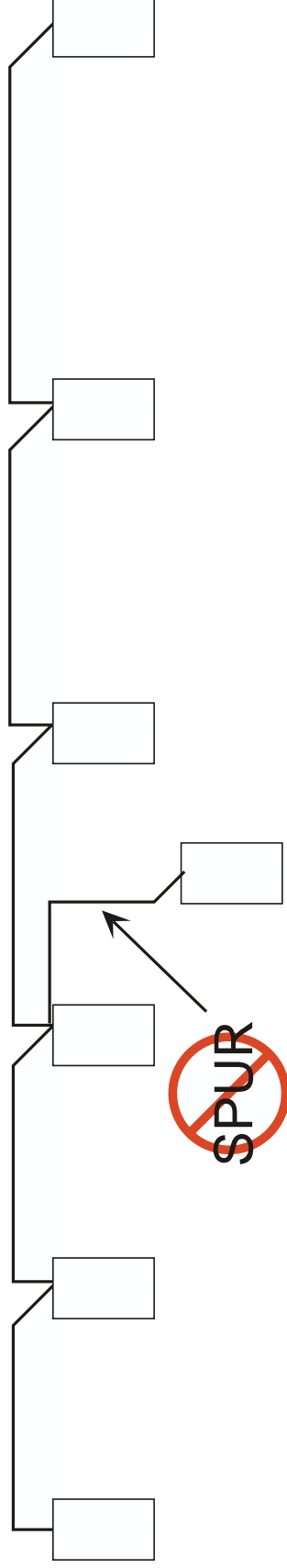

Items on the bus should be connected in sequence (no particular order needed) with no "SPURS." A Spur is any branch from the bus of more than a few (3) feet.

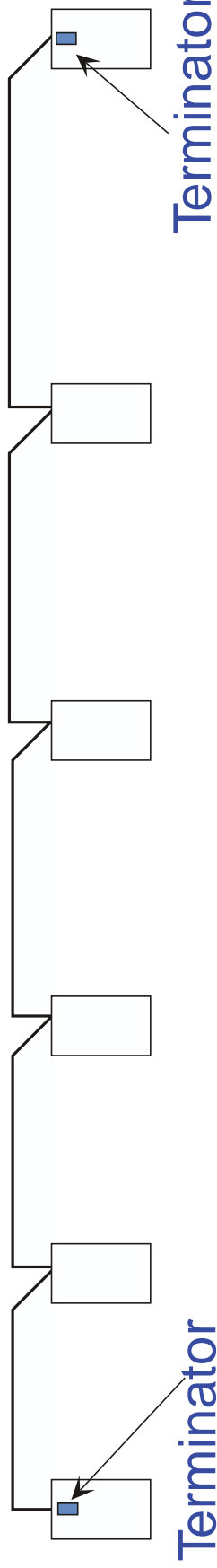

The beginning and the end of the bus should be "terminated" even in systems with just a panel and a single switch. Terminators dampen reflections that could otherwise cause data to get corrupted.

One might liken the bus to a rope with knots in it at every item on the bus. A termination could be considered to be the binding at the end of the rope to prevent fraying.



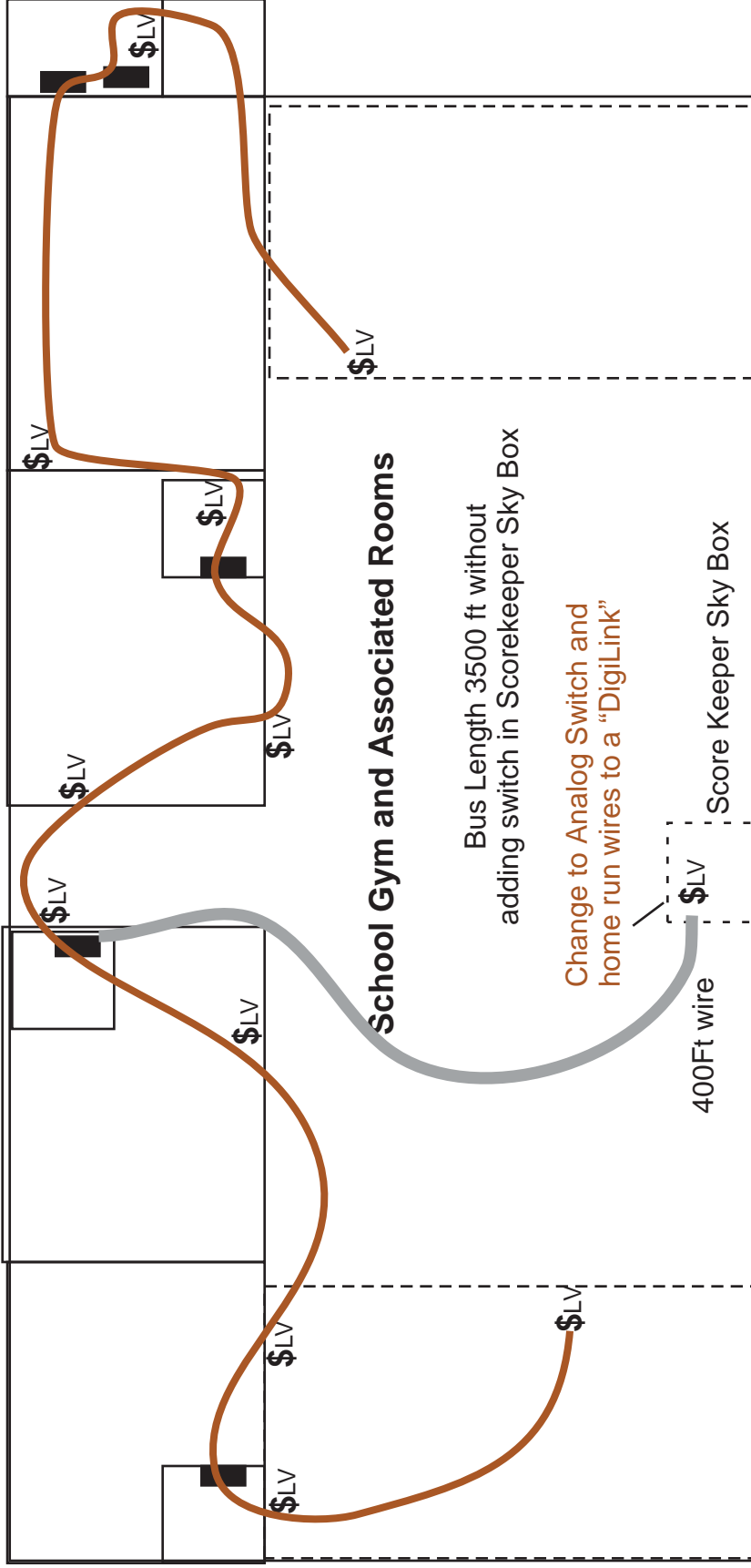

### Getting Out of Trouble Too Long a Bus

In this example of a school Gym the switches and panels were as shown in a concrete building with limited conduits. There was no way to put everything on a straight line bus and keep under 4000ft. The main problem was the Score Keep's switch which would have added close to 800 ft to the bus. (Out and Back.)

The solution was to order an analog switch with a DigiLink dry Contract input card instead of a digital switch for that one location. The Analog switch requires two wires plus one wire per button. (8 Wires for a 6 button switch.) For under 200 ft one can use Cat 5 and for longer use # 18 wire.

## Parts of the System:

### Relays

#### Standard SnapLink™ Relay



**600 Volt 2 pole relays.** These take up two single pole relay spaces and are mechanically linked 2 pole relays. They are used for dual 277Vac circuits that require a higher rating (480Vac) than the standard 277 Vac relays. These relays will be mounted in a special section since they do not fit under the usual barrier.

2 Pole relays are driven by alternate outputs from the control card. Thus if output 1 is driving a 2 pole, output 3 would be unused.

**SnapLink Relays** are rated at 277Vac 20Amps. Standard panels are shipped with Normally Closed relays so that the relay will be on during hook up and will default to ON when power is lost. This is especially necessary for emergency circuits but is also very useful on normal circuits during maintenance. Normally Open relays are also available.

**SoftStart relays** can be identified by a small box next to the terminal block. Soft Start relays are only rated for use on 120Volt incandescent lamp circuits. Please make sure that they are correctly connected and that any changes made in the field uses them on incandescent loads. They will not be damaged by switching Fluorescent loads or being run at 277 but the extra money spent on the relay will give no benefit.

**@Zero relays** may be used on any type of load. They have a solid state section that turns ON and OFF the relay at the zero cross point to reduce contact burn. They should be used for loads that require frequent cycling. They have a life of at least 250,000 throws and should last for close to a million throws.



**600 Volt 2 Pole Relay**



### Snaplink Latching Relay.

Introduced at the end of 2005 the Snaplink Latching relay is a heavy duty 347 volt relay. It is designated Normally Closed since it will snap to closed upon loss of power.

The heavy construction ensures that any dead short on the output is passed along to the circuit breaker with minimal damage to the relay. The extra large terminals can take 2 number 8 wires for loads at long distances from the cabinet.

The Snaplink Latching relay is not a Zero Cross relay yet is rated to switch 20 amps of High Output Fluorescent ballasts loads for 100,000 operations. (Most smaller relays require a zero cross circuit to handle High Output ballasts which have extremely high inrush currents.)

### Changing Relays

Relays are mounted in "Snap Track." This is an insulating holder that allows relays to be "Snapped" in and out.

First loosen the mounting screws for the barrier that both acts a clamp and a cooling fin for the relays.

Remove the high voltage connections and unplug the low voltage connections. Place a flat bladed screwdriver in the notch at the front of the relay and twist and lift to pop the relay out.

Put the replacement relay into the same location with the back side of it engaged in the track. Place the flat bladed screw driver blade on the front of the relay and give the end of the screwdriver a sharp tap to snap the relay into the track. Now reconnect the low and high voltage connections.

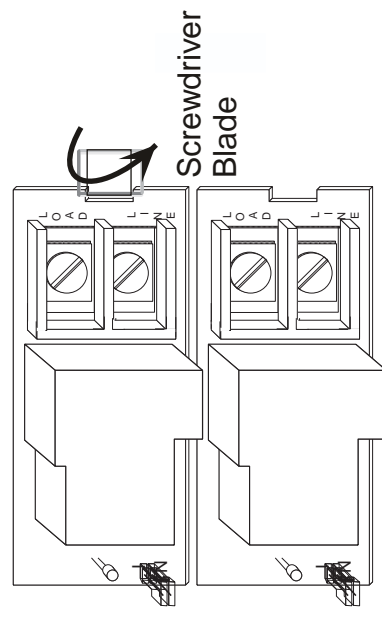

### Dual Voltage Input Card

Most systems are shipped with dual voltage input cards. These have a rotary switch that selects OFF, 120 VAC or 277 VAC.

When 277Vac is connected there will be no voltage on the 120 Volt terminal and similarly when 120 Volts is selected there will be no voltage on the 277Vac connector.

In the OFF position both the 120 and 277 volt inputs are disconnected.

The 277 Vac primary is protected with a thermal fuse, the 120 Vac primary is protected with a 1 amp circuit breaker.

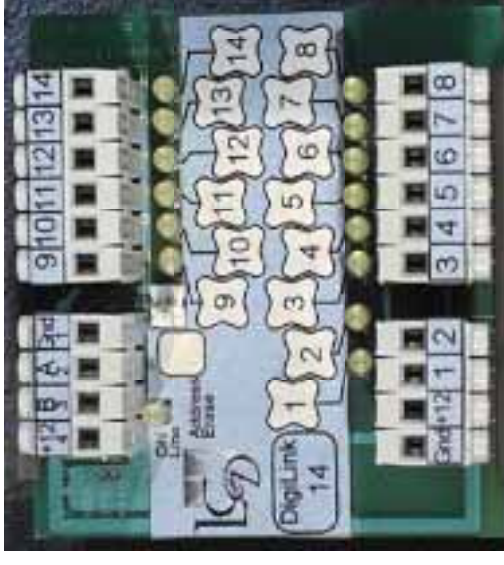
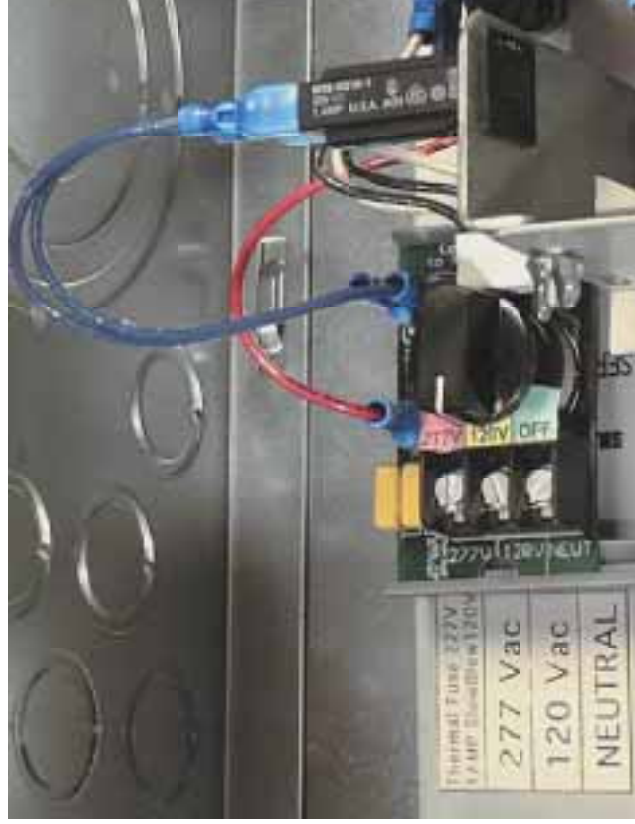

### DigiLink

The DigiLink Dry Contact Input Card is used to interface to non LC & D equipment.

The DigiLink card is connected to the GR 2400 bus in the usual way through the RJ 45 Connectors or the “1234” bus connector.

It is most usually mounted inside one of the relay panels but may also be mounted in a 6" by 4" box in any convenient location.

When used with an Occupancy Sensor an additional power supply may be needed to provide the auxiliary voltage needed by that brand of sensor.

For the hook up diagrams below only some inputs are illustrated in order to conserve diagram space. The additional inputs are wired the same way.

Note that a DigiLink appears in the clock programming windows as a 14 button switch. Each input is programmed in the exact same way as a switch button.



### Dry Contact to Energy Management System

Multiple inputs from an EMS system may be connected with a single common as shown. Normally programmed as MAINTAINED inputs.

### Hooking up Occupancy Sensors to a Digilink with Power.

A powered Digilink has a 24 volt output to power most occupancy sensors, 850 ma is available. Only use occupancy sensors that have "dry contact outputs." these are usually designated as -RP or some other option to indicate that an additional relay has been added for building automation purposes.

Connect occupancy sensors to the Scene Input indicated on the paperwork that came with the system.

A typical Occupancy sensor is a Mytech Light Owl sensor made by Hubbell Building Automation. Here is their diagram:

Hubbell Building Automation LIGHTOWL

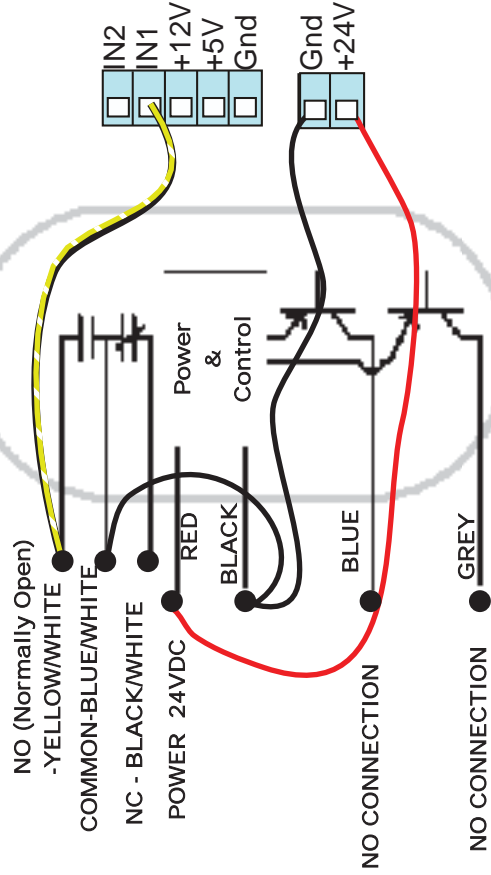

Note that we do not need to connect 4 wires to this sensor since the Blue White wire may be connected to the Ground or Black wire for the control power.

### Watt Stopper DT 200

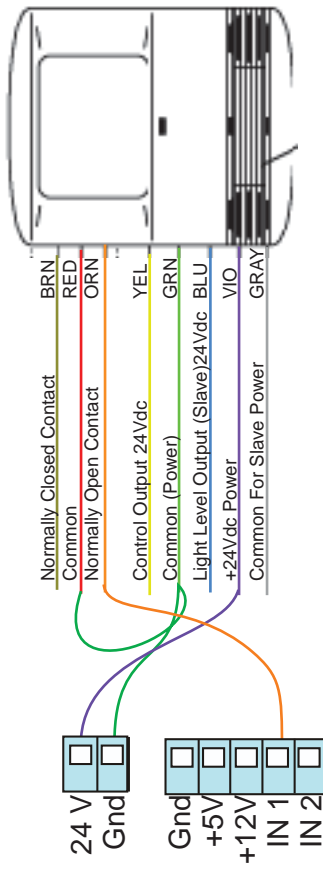

The Watt Stopper has very similar wiring to the Hubbell. The DT 200 has the auxiliary contacts built in without being an option.

### Novitas Sensors

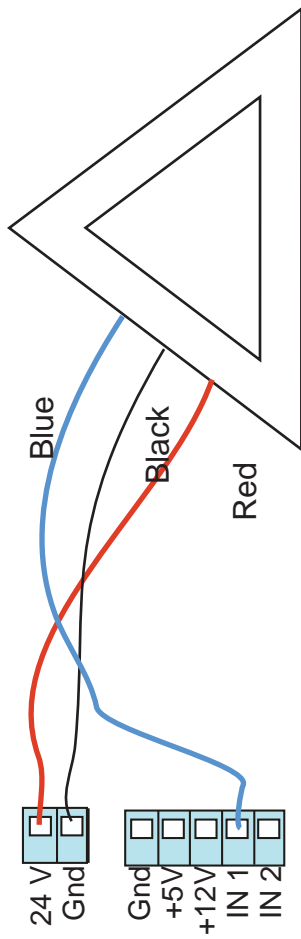

Novitas is one of the few sensors on the market that has an output that "pulls low" (using a transistor) and can be used with the GR 2404-DIM without a separate relay option.



### GR 2404 S Relay Panel

The GR 2404s is called a "Micro Panel." The GR 2404-IDH and GR 2404-IDIM have their own manual.

The "Micro Panel" is designed for use where only 2-4 relays are needed at a distance from the main panel. Running the data bus wire is less expensive than running conduit and 8 switch leg wires over the same distance.

### Special Features of the GR 2404

The GR 2404 Micro panels can also be used as stand alone panels with built in timers for an inexpensive energy management system or tennis court control system.

The hard wired inputs to the GR 2400 system can be wired as shown on the next page.

The hard wired ON/OFF inputs may be programmed via the Clock/ Programmer in the RELAY PROPERTIES MENU or if requested, in advance, by the factory to be Toggle/Off inputs or Maintain/Off inputs.

The Clock/ON Input has a dual function. If wired to a momentary switch it will act as an All ON switch to complement the ALL OFF input. All 4 zones will be switched.

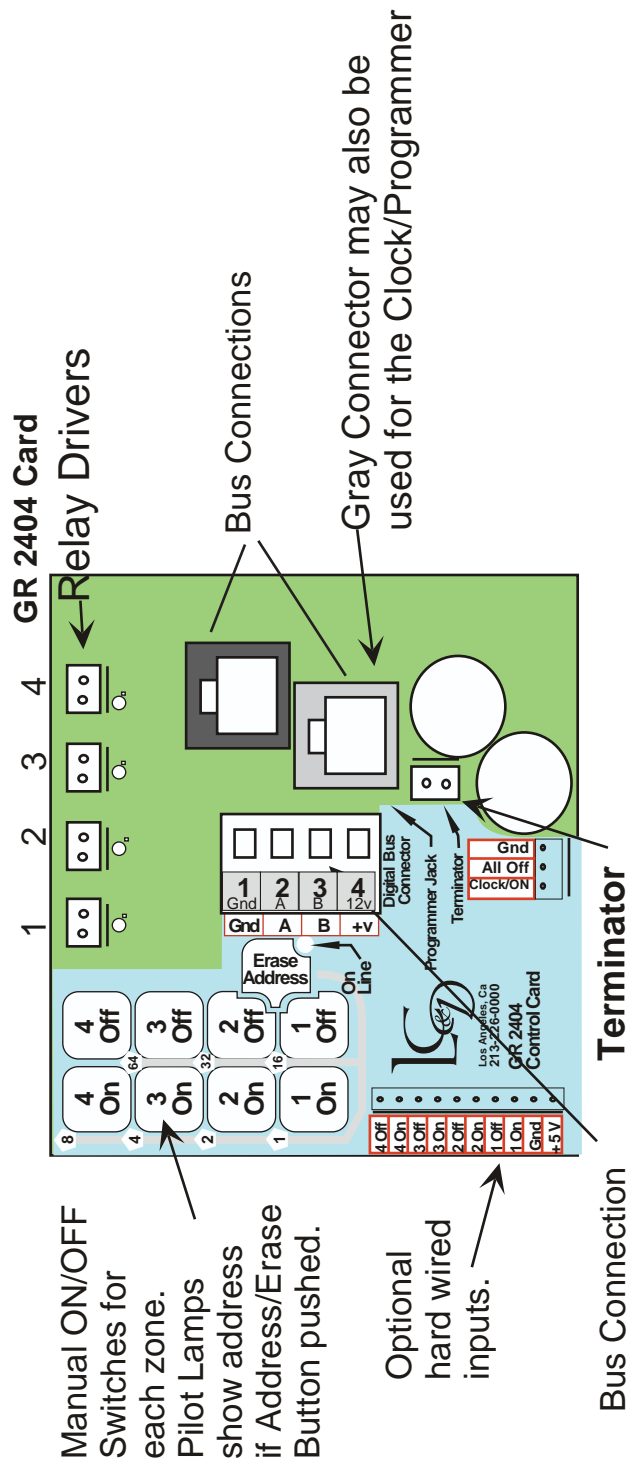

Manual ON/OFF Switches for each zone.  
Pilot Lamps show address if Address/Erase Button pushed.

Optional hard wired inputs.

Bus Connection

Terminator

Bus Connections

Gray Connector may also be used for the Clock/Programmer

GR 2404 Card

Relay Drivers



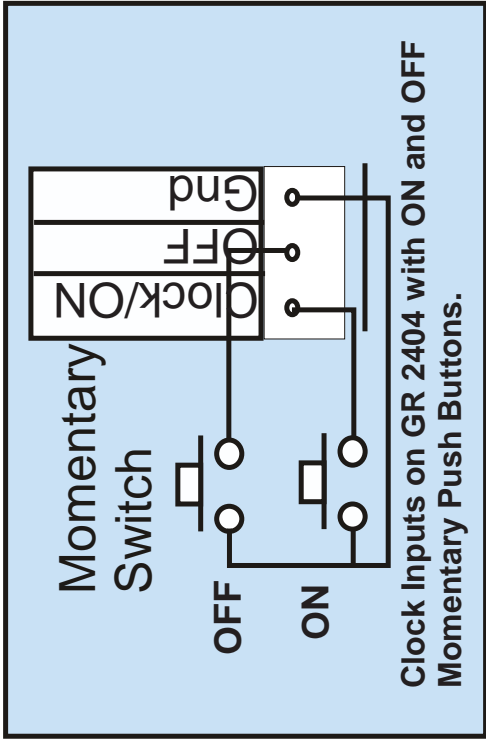

The "Clock" input of a GR 2404 acts as a momentary input for the first three seconds of the contact closure. After three seconds it becomes a maintained type input. This means that if it is connected to a push button and the button is held for less than 3 seconds the 4 relays will just turn ON. But if held for more than three seconds and then released the relays will turn ON when the button is pushed and turn OFF when it is released.

Hard wired switch input buttons may have pilot lamps on them if they are Chelsea or Knightsbridge "1 Wire" switches by LC & D.

The wire should be shielded with the shield connected to the GND connection at the panel only.

If connected to a maintained contact such as that from an inexpensive time clock it will turn ON all 4 zones on contact closure and all 4 off when the contact is released.

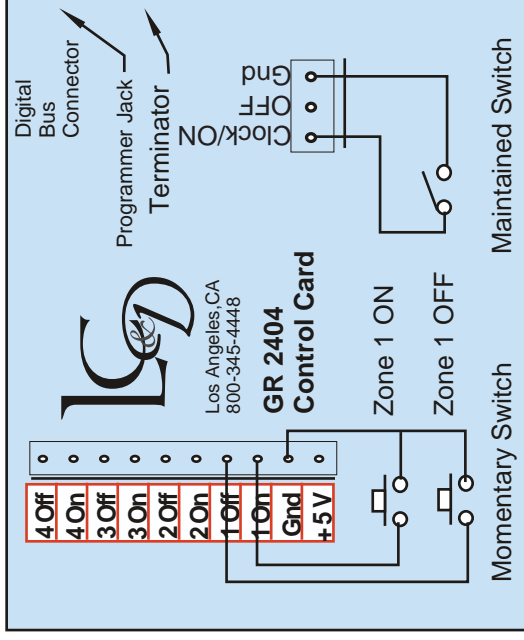

If the zones have been programmed as a Group with a 2 hour sweep and an OFF Sweep Warning then the OFF sweep will be disabled while the CLOCK contact is closed (pulled to equipment Gnd) and re-enabled when released.

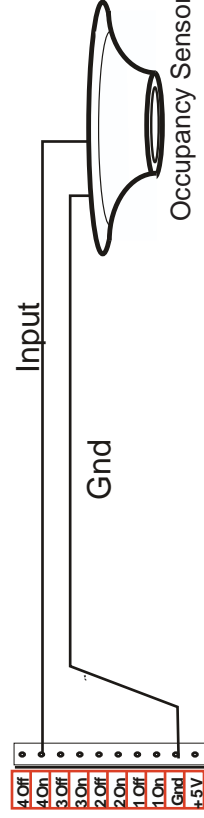

### Occupancy Sensors

Occupancy Sensors can be used with the GR 2404 but only in limited ways, Basically all ON/OFF or one input at a time. For most applications it is better to order a GR 2404-IDH.

### The GR 2432 and 2448 Series of Relay Cards.

The GR 2432/48 series of relay cards are available in increments of 16.

Panels made with this type of circuit board will contain a board that is capable of driving the full complement of relays in that panel 32 in a 32 panel and 48 in a 48 panel.

Each output is capable of driving up to 2 relays. In situations where the board is driving 2 pole Snap-Link relays (which take up two normal relay spaces) the relays should be plugged up to alternating outputs.

### Board Addressing.

Boards are addressed from the clock. For how to navigate the clock and where to find this menu read the Programming section. Put the clock into Auto Address mode, scroll to the correct address and press the "Assign" button on the card.

To check the address one can go to the READ ADDRESS screen on the clock and push the ASSIGN button to read out the address.

Boards must have a unique address not duplicated by any other item on the bus. To make life a bit more difficult boards take up additional addresses for each 8 zones or relays that the clock can "see." Read to the end of this section to get a better understanding.

### GR 2432/48 Type Cards "MODES"

The GR 2432/48 cards may be factory set in one of three MODES. The following data is for information only. There should never be a need to change the card MODE (though this is covered in the appendix.) The card will normally be sent out with a label that indicates the mode that the panel has been set in and instructions on what buttons to push in order to do the most basic functions of changing what relays are in which zones.

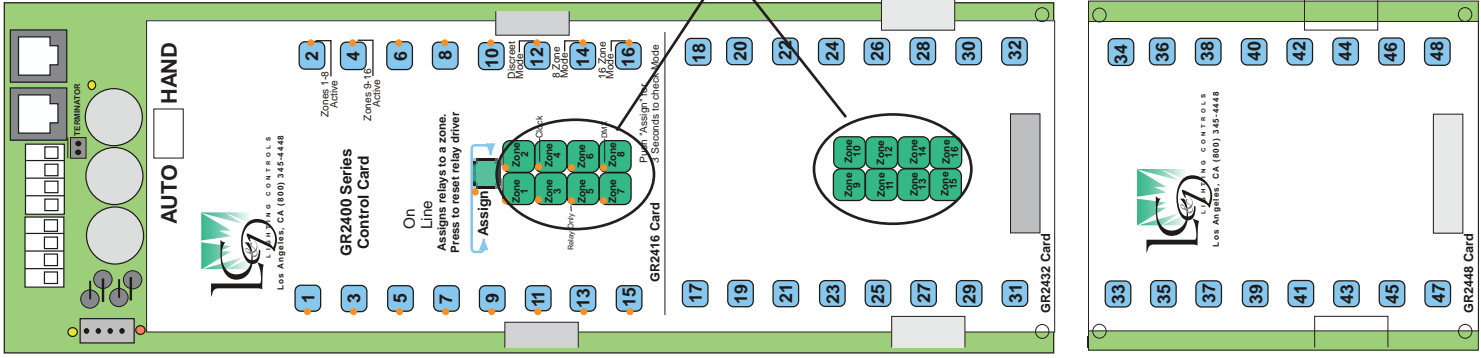

**a) 8 Zone Mode:**

In this mode the "Zone Buttons" 1-8 in the first 16 relay section are active while the 9 through 16 are not. (Or it is a 16 relay card and there is no 9 to 16)

In the 8 zone mode the relay card takes up 1 address on the bus.

**b) 16 Zone mode**

In this mode all 16 central Zone Buttons are active.

In this mode the relay card takes up two addresses on the bus with the first address being the one programmed by pushing the Assign button in the auto address mode of the clock.

**c) Discrete mode. (1 to 1 zone to relay.)**

In this mode the center buttons are **inactive** and cannot be used. The relays may be addressed individually.

A 16 Relay board takes 2 addresses on the bus.

A 32 Relay board takes 4 addresses on the bus.

A 48 relay board takes 6 addresses on the bus.

Addressing is done by bringing up the "AUTO ADDRESS" Screen on the clock and pressing the "ASSIGN" button on the board. The "Auto Address" number should be the number for the first board's address. The other addresses will then be assigned automatically. The next available address will show automatically.

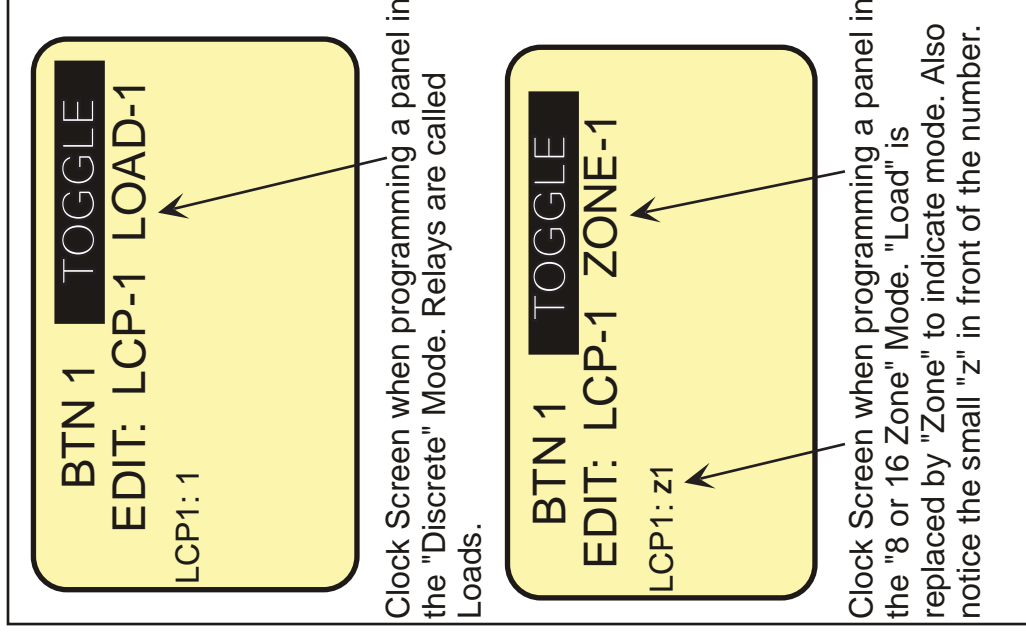

### "Discrete Mode"

In the Discrete Mode each relay in the panel is visible on the Clock display. The relays may be controlled individually or in groups as programmed by the clock. These groups or individual relays may be controlled as part of a schedule or by a photocell or switch push button.

### 8 Zone and 16 Zone Modes

In the 8 zone and 16 zone modes the individual relays are not visible from the clock. Instead only the Zones are visible. To indicate this the numbers listed in the clock will be preceded by a small "z". Also in the panel listings the word "load" is replaced by "Zone"

### Types of GR 2416 Card

The GR 2416 comes in two versions.

#### a) In systems with a DTC (Ivory) Clock.

In these systems the DTC (Ivory) Clock is both the programmer for the system and the source of Time based commands. The back of the Ivory clock has the place where the modem is connected. All control cards in such a system have an 8 Position "RJ45" connector at the top of the board to plug the clock into.

#### Clock Only Connector

**Top Section of a GR 2432/48 Card in systems with a DTC (Ivory) Clock.**

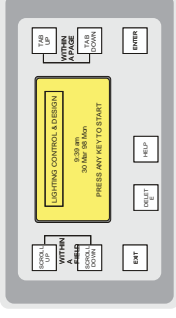

#### Systems with a BLUE BOX

Here the intelligence for the clock is built into the "Master" relay card. Usually in such a system there are not more than 3 panels. With large systems it is easier to set up the system by walking the clock around the system and plugging into each section.

The Blue Box is designed for small stand alone systems with less than 20 addresses on a bus. The Slave card for the Blue box may also be used in a GR 2400 system with a central Clock/Programmer.

### **Checking the Mode of a GR 2432/48 Card.**

If you suspect that the Factory Set Mode is not the mode your card is actually in then press and hold the "Assign" Button. After 3 seconds all the relay pilot lamps will go out and the LEDs on the right will indicate which of the center keypads is active and the mode that the board is in.

### **Rules for Relays in Zones.**

A Zone is a collection of relays that work together. There are certain rules that apply to Zones in the GR 2432/48 card and Blue Box Cards.

- 1) Relays may only be assigned to one zone. If you wish to have relays operate in two different zones then the card must be changed over to Discrete Mode. ( See the appendix)
- 2) In "Zone " Mode the buttons next to the relay outputs will still operate that relay.

If for instance the Zone is in the ON position and the relay is forced OFF with its individual control button and left that way, the zone will get it back into sync the next time the zone is operated.

- 3) One may operate all the relays in a zone by pressing the zone button. The first push is an ON

and the next is an OFF etc.

- 4) Zones only operate the relays in that panel. One cannot assign relays from a second panel to that zone.

### **Assigning Relays to a Zone.**

- a) Press the "ASSIGN" button. The Pilot light should come on. If the pilot light does not light then the board is in Discrete Mode.
- b) Press the desired zone button.
- c) Press the buttons for each of the relays that should be in that zone.

If a pilot lamp starts blinking after it is pushed it means that that relay is already in a zone. If you want that relay in the zone push the button a second time to force it to the zone. If not, leave it alone and after 5 seconds the pilot will stop blinking and the relay will not be assigned.

If you inadvertently push the button for a relay that should not be in the zone, push it again to turn off the pilot LED and take it out of the zone.



d) Press the Assign Button again to put this configuration into memory. If the Assign button is not pushed within 20 seconds of a relay button being pushed the "Assign" pilot lamp will go out and the configuration of that zone will not go into memory.

### Viewing which relays are in a Zone

To view which relays are in a Zone:

- a) Press the Assign Button.
- b) Press the appropriate Zone Button.
- c) The Pilot lights of all the Relay buttons in that zone will light.
- d) If necessary edit the relays to be in the zone by pushing buttons and then put into memory by pushing the Assign Button.

### Sequence Speed.

When there are multiple relays in a zone or multiple relays are operated together each relay is brought on in turn.

The speed at which this occurs may be set from the clock. The factory set default is one relay per 60 Hz cycle or 60 operations per second. That means it takes about three quarters of a second to turn on all the relays in a 48 relay cabinet.

This speed may be changed from Zero to ninety nine 60 Hz cycles.

Use the **Relay Parameters Menu** in the **What and When Menu** under **System Set Up** in the Clock. This is explained under "Clock Programming."

Note that when there are a lot of relays being operated the LEDs on the Relay buttons change state instantaneously but the relays themselves will then sequence. If the time between relays is more than about 2 cycles it may seem rather slow.

If a set of relays is turned ON and then turned OFF the relays that have been given the ON command but have not yet executed it will still turn ON. The OFF command will start immediately after it is given starting with the first relay in the sequence. This can be used to set up an interesting "chase" sequence.

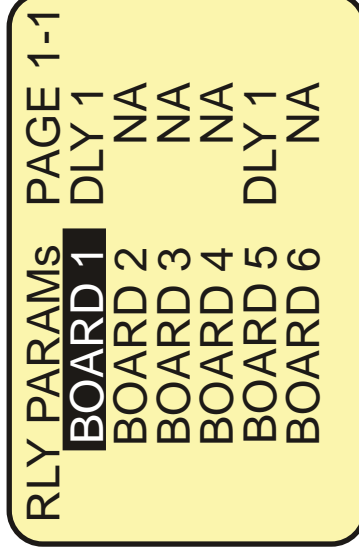

Relay Parameters Menu





## **Other Accessory Boards**

There are several additional boards that need more understanding of how the DTC Clock is programmed in order to fully understand their actions.

These include:

- a) The PhotoCell Card, 1 and 3 input.
- b) The LanLink interface.
- c) The T-Link Thermostat interface.
- d) The Lutron Interface Link-2-Lutron.

The PhotoCell card starts at page 43 and the other cards are sent out with their own manuals.

## Programming the GR 2400 System.

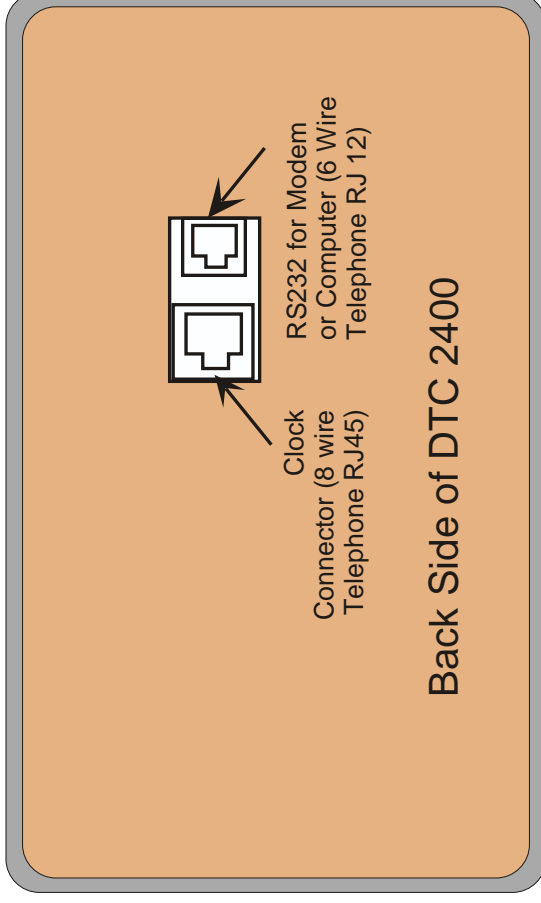
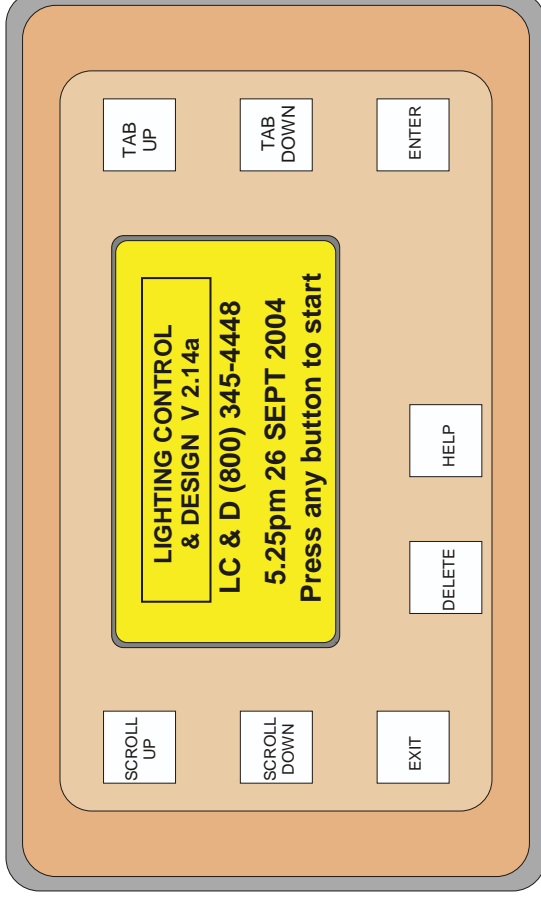

The Programmer is the front end of a system that contains the following parts:

- a) Astronomical Time Clock with 32 Schedules.
- b) Control boards that operate relays.
- c) Switches that operate the relays.
- d) Digital Switch Input cards for dry contacts from other systems. (DigiLink Card.)
- e) Photocell input cards.
- f) Thermostat Bus Interface.
- g) Other Bus interface cards (To dimming systems and EMS Systems.)

More items may be added in the future.

There is an RS 232 input socket on the back of the DTC Clock. The clock may be pulled off its mount-

ing bracket to see the RJ 12 (6 position) Phone type connector. This can be connected to a modem or a PC. The modem allows the factory or another system to program the clock remotely. Additionally new system upgrades can be down loaded from the factory to add more features as they become available. The Purchase of a modem also buys free lifetime factory programming.

### Factory Pre Programming

The GR 2400 System comes pre programmed with the program shown at the beginning of the manual. If the factory has been provided with sufficient information the system will be pre programmed exactly to your specs.

## Navigating the Clock

Scroll Buttons Up and DOWN change the values within a field

EXIT Button gets you out of a page or back to a previous page. In some pages it will also save the data to memory when you do this.

DELETE will let you delete a Schedule or a Group or when in the naming menus a letter.

A reduced version of this manual is available as context sensitive help screens. This is a fantastic feature that should be used more often.

TAB Buttons UP and DOWN are the ones to use to jump from line to line in a menu. Only fields that can be changed or take you to a new menu will be highlighted. Press ENTER to move to the next Menu or SCROLL UP or DOWN to change the value.

ENTER is used to accept data or to go forwards from one screen to the next.

Back Light will come on with the first push of a button. Nothing else is changed. The system will only accept programming when the back light is lit. No activity for 60 seconds and the backlight will turn off again to save energy.

A FIELD is anything that the CURSOR highlights. In the example shown one would press ENTER to get to the next menu.

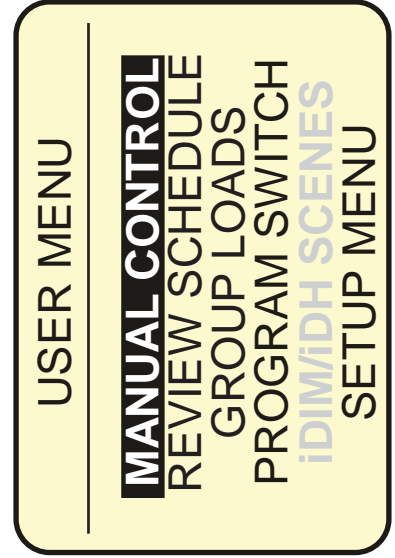
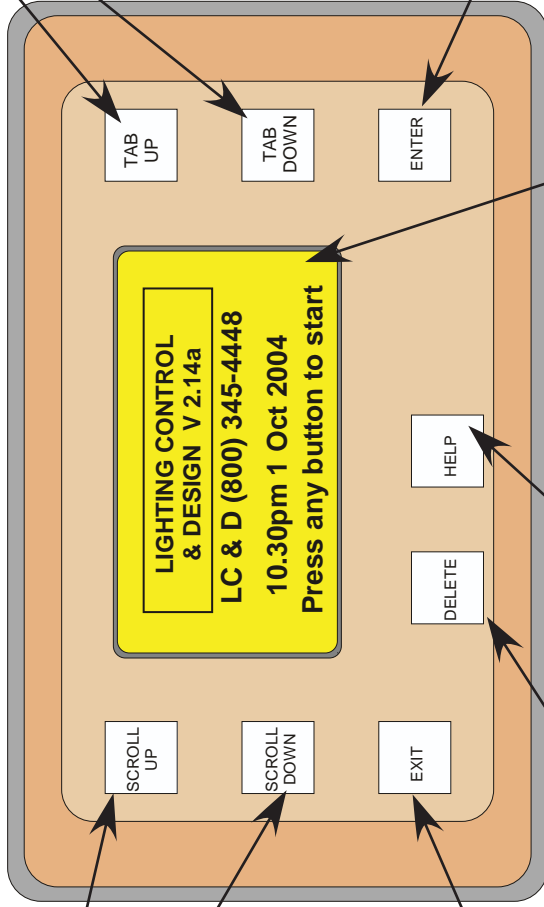

### THE USER MENU

Pressing any key on the opening page display will take you to the USER MENU.

MANUAL OVERRIDE is the menu for changing the status of any load.

REVIEW SCHEDULE is the menu for both programming new schedules and changing existing schedules.

The SETUP MENU leads to all the other menus of the system. The other three items on the menu are discussed later.

### Review/Changing a Schedule

Pressing ENTER with REVIEW SCHEDULE highlighted will take you to the Schedules Menu. There are 32 available schedules which are displayed on 6 pages. Scrolling up or down on the PAGE 1-6 highlight will take you through the 6 pages of schedules.

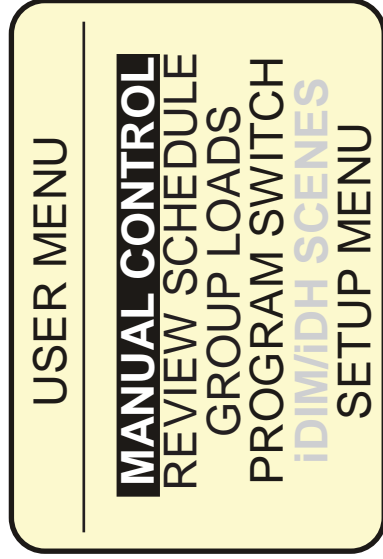

Use TAB UP or DOWN to select a schedule to edit and then press ENTER. Note that the name of the schedule being highlighted pops up at the top of the page as you tab down. This name is set up in the NAMING MENU.

The field on the right says UNUSED for schedules that have not yet been programmed and cannot be entered yet. Once a schedule has been entered this field becomes available to enter the GROUP that the schedule will control. Schedules may only control groups and there are 32 available groups in the system.

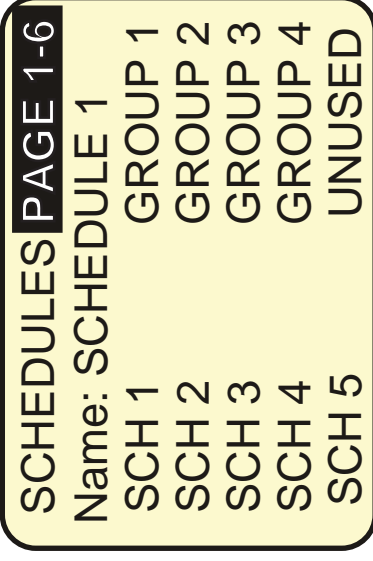

If several schedules have already been entered then use the Tab key to highlight the schedule that you wish to review or change and press ENTER.



This will bring up the Schedule with the highlight on the first field.

The Default is EVERYDAY. Scrolling on this field gives options of MON-FRI and BY-DAY which are explained later.

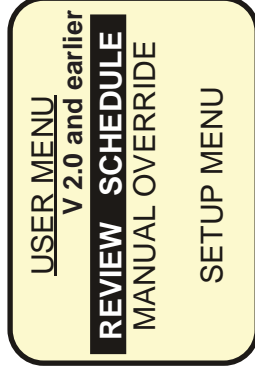

Versions of the Clock before V2.14 show some of the menu items on different pages



The default schedule is 9am to 5 pm. This gives fewer buttons to scroll the fields to their correct time in most applications.

EXCEPT NONE means that the schedule applies to 365 days of the year. The EXCEPT field may be scrolled through: EXCEPT H1, EXCEPT H2 and EXCEPT H1 & H2. H1 refers to HOLIDAY LIST 1 and H2 is HOLIDAY LIST 2. See page 33 on how to add holidays to the list.

SCH 5 EXCEPT NONE  
 EVERYDAY  
 ON DAWN+0mins  
 OFF TIME: 05:00pm

Highlighting TIME allows for scrolling through 3 other options, DAWN , DUSK, and NONE

Dusk and Dawn can be programmed as times with an offset of up to 60 minutes either before or after. NONE means that there is no ON time or no OFF time. This is used when some other means than the clock is turning ON or OFF that GROUP of relays and the Schedule will perform the other function.

Press the EXIT key to get out of the Schedule page. You will be asked if you wish to save the schedule if you have made any changes or if it is a new schedule. Press ENTER on YES or NO as appropriate.

### Monday to Friday Schedule

Monday to Friday allows for a weekday schedule and separate weekend schedules. Note that if Monday through Sat-

SCH 5 EXCEPT NONE  
 MONDAY-FRIDAY  
 ON TIME: 09:00am  
 OFF TIME: 05:00pm  
 SAT ON TIME: 09:00am  
 OFF TIME: 05:00pm  
 SUN ON TIME: 09:00am  
 OFF TIME: 05:00pm

urday are the same, one can speed programming by entering their program under the EVERYDAY menu and then changing to MON-FRI and only changing Sunday's schedule.

### BY-DAY Schedule

Use BY-DAY for setting the schedule differently for each day of the week. This menu also has the option of having the schedule operate for only parts of the year. This is useful for schools, which have holiday schedules.

SCH 5  
 BY DAY EXCEPT H1 H2  
 Mo Tu We Th Fr Sa Su

Select days to edit or review

from Jan 1 to Dec 31

Press ENTER on the day of the week to get to the time setting menu. Note that even though you are on Monday you can add other days of the week in the ACTIVE DAYS section that have the same ON and OFF times. This speeds programming.

ON TIME: 09:00:00am  
 OFF TIME: 05:00:00pm  
 ACTIVE DAYS:  
 Mon  
 Sat, Sun SAVE

**Time to the nearest Second**

This schedule allows for setting ON and OFF times to the nearest second. This is not allowed in the other menus. Seconds must be enabled in the DISPLAY OPTIONS menu. (Path:USER MENU/SETUP/ SYSTEM SETUP/SYSTEM OPTIONS/DISPLAY OPTIONS)

**After Midnight**

Programs with turn OFF times after midnight are automatically handled by the clock.

For example a restaurant is open until 10 pm on Sunday through Thursday but on Friday and Saturday nights it is open until 4 am.

Since an OFF time of 4am Saturday night is actually 4am Sunday does this require a separate schedule for Sunday? On most clocks Sunday would then have an OFF time at 4am and also at 10pm? The answer is no. The clock takes care of it. Just program Friday and Saturday as ON at say 4pm and OFF at 4 am. The clock will consider the 4 am OFF time as an extension of the previous day.

Note that this ON time is on Friday

ON TIME: 04:00:00pm  
 OFF TIME: 4:00:00am  
 ACTIVE DAYS:  
 FRI  
 EVERYDAY SAVE

While the Off time is on Saturday

Note that this ON time is on Saturday

ON TIME: 04:00:00pm  
 OFF TIME: 4:00:00am  
 ACTIVE DAYS:  
 SAT  
 EVERYDAY SAVE

While the Off time is on Sunday

Some very tricky schedules can be done with this but please make sure you think through the overlapping days so that a schedule is programmed for that day.

## Schedules and Groups

Consider that we have just programmed Schedule 5. Exiting out of a schedule takes you back to the SCHEDULES menu. Since a change has been made you will be asked if you wish to SAVE. Highlight YES and Press ENTER. This will take you back to the list of schedules in the SCHEDULES MENU.

Note that since a schedule 5 has now been programmed the space opposite SCH 5 shows NO LOADS. Tab to this space and scroll through to the next available group. This will probably be GROUP 5. If that group is already being used it will have entries in it. If not it will not. If it has entries it is better to move to another group and create a new one rather than risking interfering with earlier programming.

```

SCHEDULES PAGE 1-5
SCH 1   GROUP 1
SCH 2   GROUP 2
SCH 3   GROUP 3
SCH 4   GROUP 4
SCH 5   => NO LOADS
SCH 6   UNUSED
  
```

## Defining Groups

In order to set up a group you must know the names of the panels that the loads are in. The Master panel is usually LCP 1. Additional panels have to be added into the Panel Switch Types menu in the Factory Set Up/RESTRICTED Menu. See the Appendix for details.

## Disabling Schedules

Before going on to Groups it is important to know that one may disable a schedule by scrolling on the highlighted Schedule. This will prevent the Schedule from operating until it is again Enabled by Scrolling on it again.

```

SCHEDULES PAGE 1-5
SCH 1   GROUP 1
SCH 2   GROUP 2
SCH 3   GROUP 3
SCH 4   GROUP 4
SCH 5   DISABLED
SCH 6   UNUSED
  
```

This feature is most useful for occasions when there is an event and one wants to prevent the lights from being swept off at the scheduled time.

## Programming a Group

The action of programming a Group is very similar to programming a switch. In order to program a Group one has to list the relays or zones that are going to be in that group and also the manner in which the group is going to function. (ON, OFF MAINTAIN etc.)

**Name: LCP 1 MAINTAIN**  
**EDIT: LCP-1 LOAD-1**  
 LCP1: 1-3

The name of the panel being edited will display on the top line of the display as the number of the LCP field is scrolled. When not changing the LCP number the name of the panel and the name of the Group and its type are displayed alternately each second.

Tabbing over to the Load number and Scrolling through the relays for that panel will similarly bring up the names of the relays as entered in the naming menu.

Each panel may have up to 48 loads in it. "Load" refers to the relay number on a GR 2432 Card. Zone refers to the center buttons which have been pre programmed with one or more relays under its control.

A Group is edited by selecting the LCP number and then the load or zone number to be operated on. Scrolling the load number and hitting ENTER will either add or subtract that load from the list of loads being operated on. If the load is already listed then hitting ENTER will remove it from the list. These loads are listed in smaller type below the editing line.

**GROUP 5 MNTN+TIMER**  
**EDIT: LCP-1 LOAD-1**  
 LCP1: 1-3

List of Loads or Zones being Operated.

**Group Properties**

The top right field in this screen is the Group Properties. This describes what the group will do when initiated. A Group may have the following properties :

- a) **MOMENTARY ON.** This means that it will only turn ON the Loads listed. Usually used with push button switches.
- b) **MOMENTARY OFF .** This means that it will only turn OFF loads listed. Usually used with push button switches.
- c) **MOMENTARY MIX.** This means that loads can be turned ON or OFF and mixed as the same event. Selecting a Load and pressing ENTER on it once will make it an ON load, the next press of ENTER will make it an OFF load and the next press will remove it from the list.

The above three properties are usually used when the Group is being operated on by a Switch rather than a Schedule. The following three properties are usually the ones used by a schedule.

- d) **MAINTAIN.** Turns on the Group when the schedule turns ON and OFF when it turns OFF.
- e) **MNTN-TIMER.** This is Maintain with a timer. After the clock turns off any override switch will bring on this zone for a specified amount of time. Press ENTER on this field to adjust the Timer period which defaults to 2 hours.

**GROUP 5 PARAMETERS**  
**AUTOMATIC ON**  
 TIMER OUT: 2:00:00 Hr

**GROUP 5 PARAMETERS**

---

**AUTOMATIC ON**

TIMER OUT: 2:00:00 Hr  
 BLINK WARNING: 05 min

**MANUAL CONTROL ON**

LCP-1 LOAD-1 OFF=-

1- 3- 5- 7- 9- 11- 13- 15-  
 2- 4- 6- 8- 10- 12- 14- 16-

█ = Load is in Timer Mode

█ = Load is in Timer Mode and a BLINK warning has been issued

f) MNTN+OFFSWEEP . This is similar to the Maintain + Timer except that there is a Blink warning before the lights go off. Press enter on the MNTN+OFFSWEEP field to set the parameters of this field.

You may program the loads to come on at the ON time (Automatic ON) or to not come on with the ON time (NO AUTOMATIC ON.)

The application for NO AUTOMATIC ON is for energy savings in Offices which have low voltage override switches for each office with personnel on staggered schedules. During the night there is an OFF Sweep every (say) 2 hours. The OFF Sweep is disabled by the Schedule at say 6am, then as the occupants arrive they turn on their lights with their local switches.

**When to set the Blink Warning**

The Blink warning starts at the time the schedule turns OFF. Thus if the Blink warn time is 5 mins and the lights are to go off at 6pm the schedule may be programmed to end at 5.55pm.

**Manual Override**

The manual override Menu allows for manual operation of remote loads. This feature is useful for remote operation over a modem or computer hook up.

Select the load in the LCP that needs to be controlled and press ENTER to toggle the status of the load.

Though the load will switch almost instantaneously the display may take as much as one second to update.

**Setup Menu**

The final selection on the USER MENU is the SET-UP MENU.

We now get into some of the features of the system which are less likely to be used by the end user.

**USER MENU**

---

**MANUAL CONTROL**  
 REVIEW SCHEDULE  
 GROUP LOADS  
 PROGRAM SWITCH  
 iDIM/iDH SCENES  
 SETUP MENU

USER MENU  
 V 2.0 and earlier

**REVIEW SCHEDULE**  
 MANUAL OVERRIDE

SETUP MENU

Only here if an iDIM or iDH are on the bus. These have a separate Manual



SETUP MENU

RESTRICTED

**RELAY PROPERTIES**  
CONTACTING LC&D  
SYSTEM SETUP MENU  
(THERMOSTAT)

Only on Menu if there is  
a T-Link on the bus.

Pressing ENTER on any of the fields will take you to a different sub menu.

**CONTACTING LC&D**

Contacting LC & D gives our 800 number in case this manual is lost.

**RESTRICTED**

Restricted is the Factory programming menu which is explained in the appendix.

**SYSTEM SETUP MENU**

This menu leads to a sub menu with the options as shown. Hitting ENTER on SET TIME AND DATE leads to that menu

**SYSTEM SETUP MENU**

**SET TIME AND DATE**  
EDIT HOLIDAYS  
SYSTEM OPTIONS  
WHAT and WHEN?  
ADDRESSING-BUS SCAN

which is self explanatory. Time can be set to the nearest second and the clock starts when you highlight the last field and hit ENTER.

V 2.0 and earlier  
SETUP MENU

**SYSTEM SETUP MENU**  
GROUP LOADS  
PROGRAM SWITCH  
RESTRICTED  
CONTACTING LC & D

ENTER NEW TIME/DATE

11:35:00 am

6 Jul 1999 Tue

Time starts when

you . . . **HIT ENTER**

You may choose if Day Light Savings is to be implemented in the DISPLAY OPTIONS menu which is under SYSTEM OPTIONS.

**EDIT HOLIDAYS**

Holiday Lists 1 and 2 have 4 pages each. The first two pages are the common Federal Holidays. These include Thanksgiving which is a moveable feast. The last two pages are for other days that are not included in the generic list.

As you tab down the list of Holidays the date each holiday occurs on is shown at the top of the page.

SELECT HOLIDAY LIST

TO EDIT

**HOLIDAY LIST**  
HOLIDAY LIST 2

**HOLIDAY LIST1 PAGE 1**

New Year: NO  
 M.L.King : NO  
 Presidents: NO  
 March 13th : NO  
 Memorial: NO  
 Independence: NO

In the HOLIDAY Menu the Page # should say "Page 1-4" but there was not enough room. The fact that the field is highlighted means that it can be scrolled.

**HOLIDAY LIST1 PAGE 1**

Date: Jan 1  
 New Year: **YES**  
 M.L.King : NO  
 Presidents: NO  
 March 13th : NO  
 Memorial: NO  
 Independence: NO

To add a Holiday to the Holiday List TAB to the NO field and SCROLL UP or DOWN so that "YES" is displayed. This Holiday will now be on the list. Note that the day of the holiday is now displayed at the top of the list.

**HOLIDAY LIST1 PAGE 3**

Jan 1 1996: NO  
 Jan 1 1996: NO  
 Jan 1 1996: NO  
 Jan 1 1996: NO  
 Jan 1 1996: NO  
 Jan 1 1996: NO

Pages 3 and 4 of the Holiday list are for custom entries. Note that the year of the entry may be set so that it does not appear on the same date next year which could be a different day of the week.

If you wish it to be on the same day every year SCROLL DOWN while highlighting the default year. The Default year will then change to "ALL" meaning that the same date every year will be a holiday. The default year will change from time to time with different versions of the clock.

Any change to an entry on the custom list will automatically add a YES to the entry. To save the Holiday list EXIT from the menu and press ENTER on YES when it asks if you wish to save.

**SYSTEM OPTIONS**

This leads to a sub menu which has to do with all the permanent changes one can make to the system.

**SYSTEM OPTIONS**

**KEYBOARD LOCK CODE**

**SELECT LOCATION  
DISPLAY OPTIONS  
NAMING MENU**

**KEYBOARD LOCK CODE**

IS: 0000

Set code '0000' to disable or any other code to enable Key Lock permanently. Hit exit if not sure and see Users manual.

**KEYBOARD LOCK CODE**

This Menu allows setting of a keyboard lock code. DO NOT SET THIS CODE UNLESS THERE IS A PERSON WHO WILL ALWAYS BE AVAILABLE TO UNLOCK THE CLOCK. Usually 1234 is a good code to put in even though it is an obvious code. This way a casual attempt to break in will be thwarted.

The Security with the lock code is tight:

- a) A 5 minute wait with no key pressed and the system reverts to locked.

b) Putting in an incorrect code requires a 60 second wait before trying another code. This can be infuriating even if you know the code but just mis-keyed it.

c) If you get locked out you may call the factory for the backdoor code but we will need some sort of proof of ownership to give out the code.

**SELECT LOCATION**

This menu makes sure that you have the right location for the Astronomical timing to be correct. If your city is not in the list of cities then the Latitude and Longitude of your

Latitude: 34\*N

Longitude: 118\*W

Time zone: GMT -8

Accept Coordinates by .. **HIT ENTER**

location must be entered.

This requires entering the number of hours difference from GMT (Greenwich Mean Time) appropriate for your location. Eastern Standard Time is GMT - 5 while Pacific Standard Time is GMT - 8.

For Countries East of Greenwich the time is positive. For instance Delhi is GMT + 5.5.

## DISPLAY OPTIONS

This menu gives a list of options available in the display.

MILITARY TIME will display all time measurement in Military time. Thus 4.12pm will display as 16:12 Hr.

SECONDS VISIBLE defaults to YES. If you do not want to see the seconds on the first page display then change it to NO with the Scroll Buttons.

DAYLIGHT SAVINGS can be turned off for those areas of the country that do not have Daylight Savings. All of Arizona, parts of Texas, Illinois and Hawaii do not have Daylight Savings.

TEMPERATURE F/C is only of use if a T-Link card and Digital Thermostats are part of the system.

DISPLAY GROUPS. This turns ON and OFF the option of displaying which groups are ON or OFF as little dots on the left hand side of the display. This is not usually displayed except at the factory for testing.

## NAMING MENU

The Naming Menu allows one to put in names for each of the loads , panels, switches etc. It is a bit tedious to put in by hand but may have been input by the factory using a keyboard and can now be modified to more exactly state the scene where the clock is being used.

Military Time : **NO**  
Seconds Visible : YES  
Daylight Savings: YES  
Temperature F/C: F  
Display Groups: NO  
  
To save: HIT ENTER

NAMING MENU  
  
**GROUP NAMES**  
SCHEDULE NAMES  
PANEL -LOAD NAMES  
SWITCH-BUTTON NAMES

NAMES PAGE 1-5  
NAMING GROUP 1  
NAMING GROUP 2  
NAMING GROUP 3  
NAMING GROUP 4  
**NAMING GROUP 5**  
NAMING GROUP 6  
NAMING GROUP 7

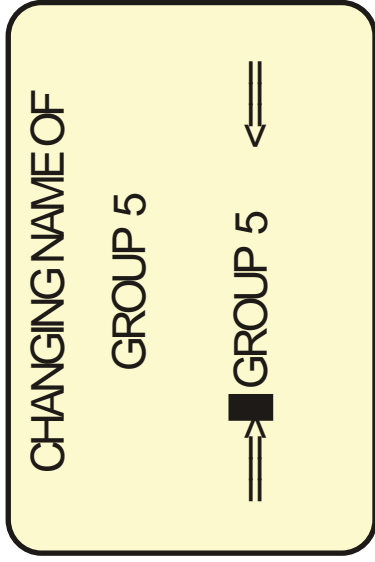

Press ENTER on the type of item that is to be named . (Say GROUPS) Tab through until you get the exact item (SAY GROUP 5) and then use the scroll up and down keys to change each letter to input or modify the name of each Group or other item.

Pressing "DELETE" on an existing letter clears it back to a space.

Note that the memory of the system is somewhat distributed. The names of each Zone is kept in the Relay board (GR 2404,2408 or 2416) but the name of the panel is kept in the clock memory. Thus if the board is disconnected you will be able to see the panel name but not the relay names.

Going back to the System Setup Menu the next item is the **WHAT and WHEN MENU**. This menu answers the above question. What controls this relay? When is the next scheduled event? etc.



### SCHEDULED EVENTS

Scheduled events lists the times in order of occurrence from all the schedules. This is a good side check on schedule programming to make sure that all the events that should be happening are in fact happening. Schedules only operate on a Group so the listing shows when Groups are turned ON or OFF.

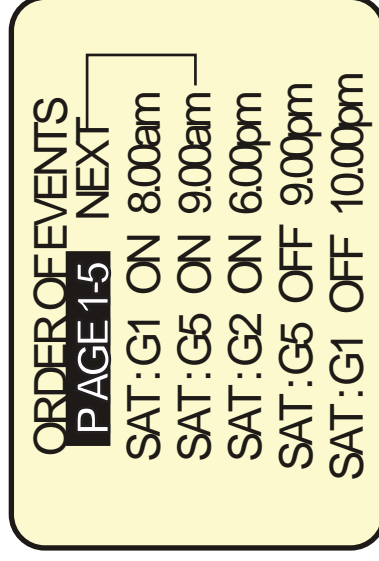

The events are listed in order from midnight of the day of the request and extend for a full week. The next event is indicated by an arrow on the first page. Items before the arrow occurred before the current time.



**WHAT CONTROLS**  
**GROUP 5**

Hit enter to scan  
the selected group.

**WHAT CONTROLS GROUPS**

Scroll to the Group number and then Hit ENTER. The Clock will scan the bus and collect the data for display on the screen.

**WHAT CONTROLS**  
**GROUP 5**  
SCHEDULE 5  
SWITCH ID#6 Btn 4

If one got the above result it would explain why the lights were going off at the wrong times since any Group controlled by a clock would not normally be controlled by a switch.

**WHAT CONTROLS**  
**LCP1 LOAD -1**  
  
GROUP 2  
SWITCH ID#4B1

**WHAT CONTROLS RELAYS**

This menu is similar to the one above except that now what controls a relay is listed.

Notice that now there are two fields that have to be scrolled, first the panel or LCP number and then the load within that panel.

**RELAY PROPERTIES Menu**

This menu will change the parameters of each of the relays on a relay card.

**RLY PARAMS PAGE 1-1**  
**BOARD 1** NA  
BOARD 2 DLY 1  
BOARD 3 NA  
BOARD 4 NA  
BOARD 5 NA  
BOARD 6 DLY 1

The address of the board is the number after the board. Thus BOARD 1 is at address 1.

"NA" Refers to the fact that this board does not have a programmable delay time associated with it. The programmable delay time is the number of 60 Hz cycles between each relay operation. It may be set between 0 and 99 on GR 2416/32/48 series cards ONLY. A GR 2404 or GR 2408 does not have this capability. They have a preset delay of two 60 Hz cycles.

**Changing the Delay Time between Relay Operations on a GR 2416 or GR 1416 Board.**

To change the delay highlight the Board number that has a "DLY" opposite it. Scroll UP or DOWN to change the delay in 60ths of a second.

SCROLL  
UP

**RLY PARAMS PAGE 1-1**  
BOARD 1 NA  
BOARD 2 DLY 1  
BOARD 3 NA  
BOARD 4 NA  
BOARD 5 NA  
**BOARD 6** DLY 2



To prevent such loads from being blinked it is best to tag them as "No Blink" relays. This will prevent them from being blinked as part of the warning at the end of a schedule. This type of load may receive a warning by using the HORN ALARM output of specially ordered GR 2408 cards.

**Sentry Switch (Only on GR 2404 and GR 2408 Cards.)**

Sentry Switch is used for loads that are controlling special Brand Name switches called "Sentry Switches." These switches are always powered and act like normal wall switches. A break in the power line for 5 seconds will cause a solenoid in the switch to kick it off. The Sentry Switch setting will make the relay output Normally Closed and will make an ON command irrelevant. OFF will turn the output OFF for 5 secs and then revert to ON.

**Other Individual Relay/Zone Parameters**

Press ENTER when the cursor is on the relevant relay of any one of the three listed parameters (Normally Closed, Blink or Sentry Switch) to get to the individual relay/zone properties menu:

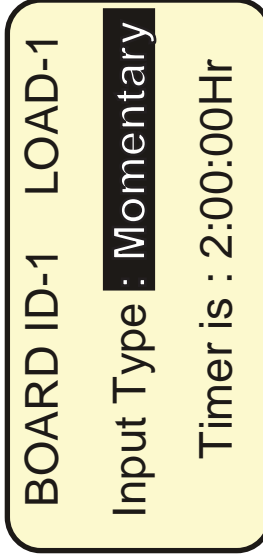

Scrolling on Momentary changes the properties of the hard wired inputs of the GR 2408 and 2404 cards. The ON input on these cards can be changed from a Momentary ON to a Momentary TOGGLE or to MAINTAINED. The OFF input remains unchanged.

The value of the Timer is usually set by adding that relay to a Group. Occasionally a board is disconnected when a Group is erased and the timer will remain active. It can be disabled in this menu by scrolling on the TIMER.

Alternatively a timer can be set for a relay that is not part of a Group but is controlling a single timer output such as a corridor light. Times may be set from 1 second through 4 hours

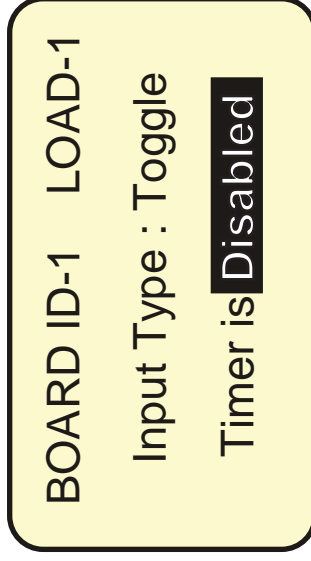

This completes the "What and When" Menu. Returning to the System Setup Menu the last item is:

**ADDRESSING - BUS SCAN**

Each card on the bus has a unique address from 1 to 127. (The DTC is address 0.) The address is usually written in on a small label either on the card or next to it by a factory technician doing final programming and check out of the system prior to shipping.

This is a very useful menu. It is used to add additional components to the bus and to check that the bus is "stable."

Once the system has been set up it is important to look in this menu to make sure that the bus has been properly terminated and that the clock can "see" all the components on the bus. See Appendix II for a checklist.



right now it will eventually cause a problem. Usually it is a bad connection or a broken wire at a switch that was recently moved. It may also be an extra terminator on the bus that must be removed.

This ends the section on the System Set up Menu .

Returning to the SETUP MENU the next item is:

```

SETUP MENU
SYSTEM SETUP MENU
GROUP LOADS
PROGRAM SWITCH
RESTRICTED
CONTACTING LC & D

```

**GROUP LOADS MENU**

The GROUP LOADS Menu lists all the Groups that are available and their status. Programming of Groups has been covered under the Schedules Menu on page 33 & 34. Please look at those pages for Programming information. To program a GROUP highlight the group and press ENTER.

```

GROUPS PAGE 1-5
Name: GROUP 1 ON
GROUP 1 USED OFF
GROUP 2 USED OFF
GROUP 3 UNUSED OFF
GROUP 4 UNUSED OFF
GROUP 5 UNUSED OFF
GROUP 6 UNUSED OFF

```

A Group that has the parameter of being MNTN + TIMER or MNTN+OFFSWEEP that is in the OFF state will be receiving an OFF command every 2 hours (or other time as set in the parameters menu). If the Group has been turned ON either by a Schedule or an Energy Management Interface the off sweeps will be disabled. One can also override the Clock or Energy Management system by manually turning ON or OFF a group. Highlight the Group concerned and SCROLL UP to turn it ON and SCROLL DOWN to turn it OFF.

A Group that has a MOMENTARY ON , MOMENTARY OFF or MOMENTARY MIX parameter will assert that Momentary command each time it is turned ON. (SCROLL UP is pressed.) The OFF command, SCROLL DOWN, does nothing.

**ON/OFF SEQUENCING**

There is a special function built into the Groups and Schedule menu that was not mentioned earlier. The earlier section being for end users it was not needed.

This function is called SEQUENCE and allows a group of loads to always turn on in sequence and then turn OFF in sequence. The time delay between relays may be set from 1 to 60 seconds. The application is for Audio equipment where one wants the preamps to be turned ON and settled down before turning on the Power Amps. There may be other applications. If it is needed for an Audio application then we recommend special ordering a custom GR 2408 card that comes up with the relays OFF in event of power failure. Standard boards return the loads to the same status as before the power failure with no sequence action. This could damage loud speakers and negates the whole purpose of the sequencer.



### Programming a Sequence

- a) Set up a Schedule to turn ON and OFF the Sequence. If you do not actually need a schedule it can be a dummy schedule that only turns it on for a minute a day.
- b) Exiting from the Schedule highlight the NO LOAD Field. Scroll **down** instead of **up** and it shows SEQUENCE. Press ENTER.

**SEQUENCE    PRESET: 1**  
**1st ID: 1    # RLYS: 16**

1: 1	2: 1	3: 1	4: 1
5: 1	6: 1	7: 1	8: 1
9: 1	10: 1	11: 1	12: 1
13: 1	14: 1	15: 1	16: 1

c) Put in the following Data: 1st ID is the address of the relay board that is controlling the relays. #RLYS is the number of relays to be sequenced ON. Preset is the time value in seconds of most of the time delays. This can be edited individually later. Note that the relays in the sequence will always start at # 1 of the board concerned and will go across additional boards as long as they are in numerical order of addresses.

The example shown in the display uses a GR 2432 card in 16 zone mode with addresses 1 and 2.

- d) Change the individual sequence times by tabbing to the correct relay and scrolling that field.
- e) To control the sequence from a switch program the ON button to be GROUP 31 MAINTAINED and the OFF button to be Group 32 MAINTAINED. The ON button will then start the sequence and the OFF button will sequence the relays backwards to the OFF position. Note any single load may be programmed to the switch in the Group. The Unplug the switch from the Bus and erase the load. A button programmed to Group 30 in the same way will stop a sequence in progress.

### PROGRAMMING SWITCHES

Pressing ENTER on PROGRAM SWITCH takes you to the Switches Menu.

This lists the switches that the GR 2400 system can see on the bus and which were entered in the factory set up. If a new switch is added to the system without being listed in the Factory Setup it will not be listed in this menu. If the switches are not plugged in you will also not be able to see it. See the appendix for more details contained in the RESTRICTED MENU as explained in the appendix.

**SWITCHES    PAGE 1-1**  
**ID#4: ENTRY**  
**ID#5: OFFICE**  
 (Names entered in Naming Menu)

### PROGRAMMING BUTTONS

Pressing ENTER on a highlighted switch brings you to the button menu. The number of buttons that the switch has is determined from the data input into the FACTORY SETUP Menu. Thus if this data is wrong it will be wrong here. A Switch may have from 1 to 14 buttons. A 14 button switch is actually a "DIGILINK" dry contact input card.

**SELECT BTN SWI ID # 5**  
**Page 1-1**  
**B1: ENTRY**  
**B2: SOFFIT**  
**B3: TRACK PERIM**  
**B4: TRACK CENTER**  
**B5: SIGN** (Names entered in Naming Menu)  
**B6: ALL OFF**

Pressing ENTER on a selected Button takes you to the button programming menu. This looks very like the Group programming menu and works in exactly the same way. The choices however for the properties of a button are different.

Any button may have the following properties:

a) ON MODE. This means that all the loads listed will be turned ON when the button is pushed.



b) OFF MODE. This means that all the loads listed will be turned OFF when the button is pushed.

c) MIX MODE. This means that the items listed next to ON will turn ON and the items listed next to OFF will turn OFF. As with the GROUP MENU the way to get an item into the ON list is hit ENTER once. A second push with the same load selected will place it in the OFF list and a third push will remove it from both lists.

d) TOGGLE. This means that the load listed will turn on with the first push of this button and OFF with the next push and so on. It is strongly recommended that only one load be listed per button to avoid the possibility of multiple loads getting out of sync. However, many systems that have some way of ensuring that the zones or relays may be put back into sync, such as the same loads also have an ON or OFF switch or a schedule on them have worked successfully. Should they get out of sync (which is very rare) the ON or the OFF button will get them back into sync again.

e) MAINTAIN. When the button is pushed in the load will turn ON and when the button is released the load will turn OFF. This is usually used for a Digilink where an external contact closure from a photocell or clock or Energy Management System will control multiple loads.

f) GROUP. A switch may only address up to 8 loads individually. In order to command more than 8 loads it has to be assigned to a GROUP. There are 32 Groups available to a system. In the last 5 years there has not been a system that used all 32 groups.

Once a button is assigned to a GROUP it may have the functions of: Momentary ON, Momentary OFF, Momentary MIX, Maintain, Maintain + Timer and OFF Sweep Maintain +Timer. Note that a GROUP may not have a TOGGLE function.

If more than 8 loads are assigned to a switch button the system will automatically ask if you wish to assign this button to a group. If you press ENTER on YES it will give you the next available group number.

### Copying a Switch.

There are often occasions where a 3-way situation is set up with identical switches at different ends of a room or corridor. Switches may be copied as follows:

In the List of switches highlight the switch to be copied. SCROLL UP to put that switches data into a temporary memory location. Tab to the switch that should be the same and highlight it. Now SCROLL DOWN to copy the data to that switch. This can save a lot of button pushing.

## Additional Features in Clock version 4.16

FACTORY SETUP MENU  
**ADDRESSING BUS SCAN**  
 PANEL/SWITCH TYPES  
 RELAY PROPERTIES  
 REMOTE SYSTEM MENU  
 OWNER SETTINGS  
**ERASE OPTIONS**

The Erase Options Menu has been changed:

ERASE OPTIONS  
 ERASE BY ADDR. BTN  
 DEFAULT NAMES  
 ERASE RELAY BOARDS  
 ERASE CLOCK MEMORY  
**ERASE BY ADDRESS**

One may now erase a card by its address remotely without pushing the address button on that card. This is particularly useful when one does not have a partner to help do the remote button pushing.

**!!! WARNING !!!**  
**PANEL/SWITCH TYPES MUST BE SET PROPERLY FOR THIS ADDRESS BEFORE YOU ERASE !!!**  
**ERASE ADDRESS: 1**

Note: If you need to remotely change the address of this card then it may be done in the MORE DIAGNOSTICS Menu under the ADDRESSING BUS SCAN Menu.

FACTORY SETUP MENU  
**ADDRESSING BUS SCAN**  
 PANEL/SWITCH TYPES  
 RELAY PROPERTIES  
 REMOTE SYSTEM MENU  
 OWNER SETTINGS  
 ERASE OPTIONS

BUS SCAN DISPLAY now has two sections to the Error field

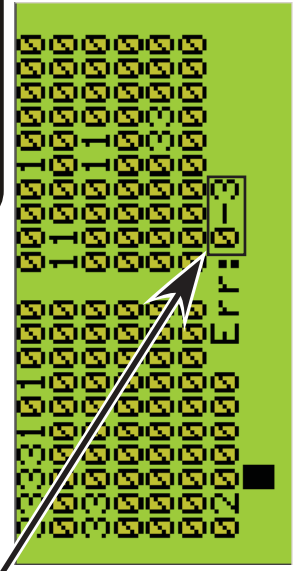

As before each location on the screen represents an item on the bus. There are 127 locations for these items. The clock is always at address Zero to make 128 items. Each 3 represents an 8 relay card or part of a Relay card, each 1 represents a photocell or switch or a digilink. This screen is considered to be a "PRESENCE MAP" of the system and shows what is present and what is not.

The Error count is divided into two sections. The first number is the number of actual drop offs from the bus. The second number is the number of failed communications encountered during the bus scan. The Black dot at the bottom is an indicator that shows that 8 items have been scanned each time it moves. Scanning is done by a "are you there" command. A single bit response of pulling the bus low is used to speed up the scan.

If a particular address does not respond or an answer is not received the second counter is incremented and the address is polled again. The lack of response may be due to a collision with a button being pushed or noise on the bus or a reflection due to lack of a terminator. If no response is received on the third poll the item is counted as "dropped" the first number is incremented and the scan moves on.

The DROP OFFs count starts at zero each time the screen is opened. The Communication failures are incremented until the clear button is pressed in the ERROR STATISTICS screen. These counts are also shown by address in additional screens in the MORE DIAGNOSTICS menu.

ADDRESSING BUS SCAN leads to the Bus Diagnostics menu which now has additional items.

BUS DIAGNOSTICS  
 AUTO ADDRESSING READ ADDRESS  
**BUS SCAN DISPLAY**  
 ERROR STATISTICS  
 MORE DIAGNOSTICS

BUS DIAGNOSTICS  
 AUTO ADDRESSING  
 READ ADDRESS  
 BUS SCAN DISPLAY  
**ERROR STATISTICS**  
 MORE DIAGNOSTICS

ERROR STATISTICS leads to the screen below



There are many error reports available from this page but they individually do not give much data. Knowing how each works gives a fairly good view of how the system is doing.

**OVERALL:** This is the cumulative number of errors since the last time that the CLEAR button was pressed. There are a total of 64 different commands that the clock can send out on the bus. Each one is monitored. If the expected result of sending that command is not received back then this counter is incremented by one. That is all this counter does. As such it gives an overview of how stable the bus is. As a matter of experience we have found that if this counter does not increment at all in a three minute period the bus can be considered stable. Over a longer period of time we do have occasional collisions of Switches asking for status updates and the Clock doing its slow turn around cycle that will cause this counter to go up a few counts per day.

**ADDRESS:** This field can be scrolled on to show the number of communication failure by address. The data in this field is NOT the same as the data shown by address in the next page. This is to do with command monitoring. The other page is to do with the “presence map”. This is not particularly useful because sometimes one will get a perfectly good address showing a lot of errors when the item just prior to it on the bus, which is the one actually causing the problem, shows no errors at all.

**COMMAND:** This is the cumulative number of errors by command. This is only useful to the technicians who are testing revisions to the software. The end user need not look at this.

EEPROM FLAG ERROR  
 EEPROM WRITE ERROR

These both refer to the memory management within the clock. If either one of these is not zero the clock must be replaced.

**DROP-OFF:** This is the cumulative number of actual drop offs of an item on the bus (failed three presence commands). If a bus is still being worked on and switches are being added or removed or the bus unplugged in sections then this is going to add up quickly. Other than that it should not go up at all. Maybe 1 per week and the bus is still stable.

**FATAL-ERROR:** This refers to memory read and write commands sent to items on the bus other than the clock. This should always be zero. If the bus is being worked on it may increment if the item is removed while a write or read was in progress. Any number in this box means that the bus is either not stable or that there is an item that needs to be replaced.

After the ERROR STATISTICS is the MORE DIAGNOSTICS screen:

BUS DIAGNOSTICS  
 AUTO ADDRESSING  
 READ ADDRESS  
 BUS SCAN DISPLAY  
 ERROR STATISTICS  
**MORE DIAGNOSTICS**

MORE DIAGNOSTICS  
 DEFAULT TO MAIN: **Yes**  
 TRIGGER: NONE  
 DROPOFF STATS 1-80  
 DROPOFF STATS 81-127  
 RESET COUNTS  
 SCAN BY FACTORY-ID

**DEFAULT TO MAIN: YES** means that after a few minutes the screen will go back to the opening screen. Sometimes when trouble shooting one wants to keep a screen open so one can choose NO. This prevents jumping out of a screen at the wrong moment. It will revert back to YES at midnight.

**TRIGGER: NONE** is only used when a special software is loaded to debug a new program in the clock. It is only used by the programmer and should never be changed.







**Scan by Factory ID**

**MORE DIAGNOSTICS**

DEFAULT TO MAIN: Yes  
 TRIGGER: NONE  
 DROPOFF STATS 1-80  
 DROPOFF STATS 81-127  
 RESET COUNTS

**SCAN BY FACTORY ID**

Items at the same address will sometimes work and sometimes not. They cause a bus to be slow and unresponsive and may make the clock reset because it waits too long for a valid answer due to the conflicts caused by two items answering at the same time.

**FACTORY ID-SCANNING**

Hit **ENTER** to scan for all items on the bus, or **EXIT** to quit.

**FACTORY ID-SCANNING**

Scanning complete.  
 Found 11 items.  
 Collisions: 0  
 Not Addressed : 0  
 Hit **ENTER** when ready

No Collisions

Even when no collisions are found one may wish to change the address of an item so that a new item can be added to the bus at that address. Press ENTER to find the item on the bus.

**FACTORY ID-SCANNING**

Item - ID - ADDR  
 1 1601 7 SAVE  
 No address collision found on this card

The "item number" refers to the order of items found by the Unique Factory ID, not the address of the item. One can find the address number by scrolling on the Item Number. One may then scroll on the address number to change it. Press SAVE to upload it and then re-scan to make sure it does not overlap something else. Make sure that PANEL SWITCH TYPES is updated as necessary.

With Collisions

**FACTORY ID-SCANNING**

Scanning complete.  
 Found 12 items.  
 Collisions: 2  
 Not Addressed : 1  
 Hit **ENTER** when ready

Scanning with Collisions

If the bus comes up with collisions they will show up like this:

Collisions means that there is more than one item at the same address.

Not Addressed means that that item has a Zero Address.

Both items need to be handled by being re-addressed which can be done remotely if you know which item is which from the unique Factory ID.

**FACTORY ID-SCANNING**

Item - ID - ADDR  
 1 1601 7 **SAVE**  
 An address collision with item 4 is detected  
 Please re-scan after fixing

In the example above it shows that ITEM # 1 is at address #7 and has a collision with item 4 which will also be at address #7. The question is which one of these should be at address #7. This requires looking at the bus file and finding out the location of the item at address # 7. Say it is a switch in room 303. Now we have to have someone physically go to the switch while the clock screen is set to "READ ADDRESS" and push the address button. When it reads the address the unique ID will also be listed. Say it is shown as 1601. That means that item 1 is the valid item on the bus and item 4 is the one with the invalid address.

Usually this would be done just after adding a new item to the bus. Then the one that was added would be the suspect device.

The new address can be scrolled to for the offending device and highlight SAVE and press ENTER to re-address that item. Make sure it is added to "PANEL SWITCH TYPES."

There is another new menu that is not listed in the earlier versions of the manual. This is the **SCHEDULE PROPERTIES** Menu.

This menu is so that one may disable schedules over the bus. This menu allows one to define a virtual panel that emulates the status of each schedule. If the relay is ON then the Schedule is disabled.

Note that **NUMBER OF PANELS** refers to the number of 8 relay cards in the panel. On a bus that is quite full one may not need to disable more than 8 schedules. If that is so **NUMBER OF PANELS**: would be set to 1 and **PANEL SWITCH TYPES** would only list one panel.

Here **PANEL SWITCH TYPES** has been set for four 8 relay sections which means all 32 Schedules are emulated.

The panel shows up on the bus scan display just like any other panel.

The panel may be controlled in the **MANUAL** Screen. This shows that the first four Schedules have been disabled.

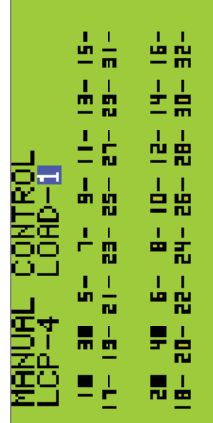
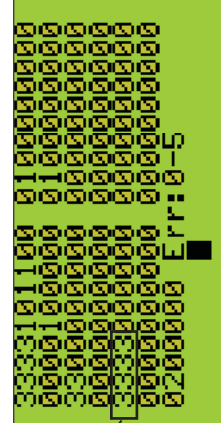
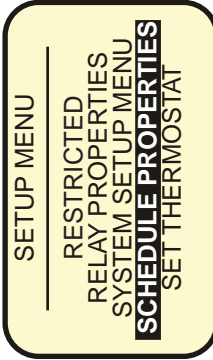

This is what the Schedules screen looks like with the first 4 Schedules disabled over the bus and Schedule 1 additionally disabled by scrolling on the schedule.



Relay 1 of LCP 4 has been turned off so the schedule is no longer disabled over the bus but it is still disabled from the schedules screen.

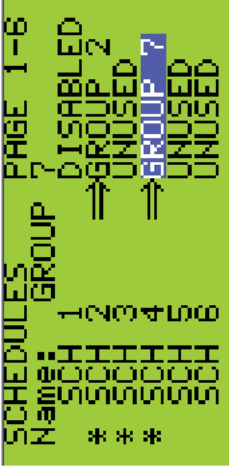

Note that as in this screen a Schedule may control the relay that disables another schedule. It may also be controlled by a switch or photocell or anything that can control a relay.



**Time Base Features**

The opening screen of the clock shows the Sunrise and Sunset times being rotated with another line that usually says "ON 60HZ TIME BASE."

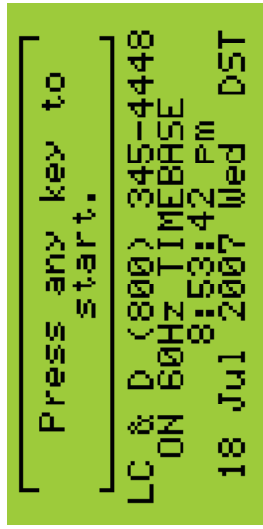

**Automatic Sensing**

Usually the clock wants to keep time by looking at the 60 Hz from the mains. This is because, by law, it must remain with 1 minute a year as a time base. Errors are made up for by speeding up or slowing down the generators to keep this accuracy. In the past this meant that we could only plug the clock into a panel where there was a "CLOCK ONLY" RJ 45. Now it is possible to plug the clock into a switch and it will still work. The sign will now say "INTERNAL TIME BASE." The clock will also automatically sense 50 Hz when in a country that has that type of electricity.

## Photocell Control Cards

Photocells are programmed like switches so they are covered in the switch section. There are two types of control card that are used with photocells. The Single and the Three input photocell card.

### Single Input Card

The single input card (Also called a "PCC 1" card) is the most frequently used card. It is usually mounted in the panel that is closest to the roof. It plugs into the bus and is powered from the bus.

It may also be mounted in its own 6"x4x4" box so that it can be located closer to the photocell.

Two #18 wires are run out to the sensor. These should be a twisted pair and run at a distance away from any current carrying high voltage conductors. The resistance of the sensors is over 2000 ohms so for short runs # 24 AWG wire is acceptable.

### PCC-3de Photocell Control Card

The three input card called a "PCC 3de" Card can accept three photocells. The "de" stands for digital enable since it may be programmed to disable the photocells at certain times of the day.

LC & D sets up the cards for use with Photocells but in fact the cards may be used with any type of sensor that gives a linear output.

Another example would be a Temperature sensor.

The reference voltage supplied to the sensor is 8.2 Volts dc provided by a 1% voltage reference. A total of 1 ma is available for sensors. The analog inputs are read between the voltages of 0 Volts and 4.1Vdc with a resolution of approximately 1000 points.

The Indoor Photo Sensor is used for daylight harvesting situations when a certain foot candle level is required. It has a response curve close to that of the human eye.

Photocell Connector  
**NOTE:**  
 Connections are Polarized  
 Connect Red wire to 8Vdc



PCO-Photo Cell Outdoor

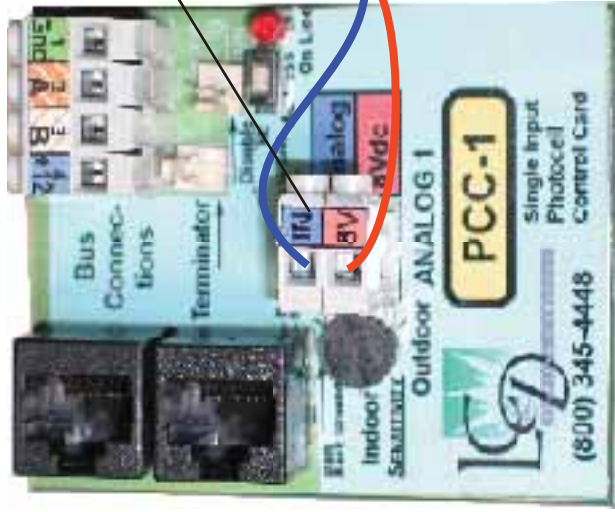

PCC1, Photocell Control Card with one Input



PCI-Photo Cell Indoor

PCC3, Photocell Control Card with three Inputs



### Programming Photocells

Photocells are essentially switches that trigger at certain light levels. They may be programmed by selecting the photocell card from a list of switches.

**SWITCHES PAGE 1-1**

ID # 4 : ENTRY SWITCH

ID # 5 : OFFICE SWITCH

**ID # 6 : PHOTOCELL**

Pressing ENTER takes you to a list of "Triggers." Each trigger is like a switch button in that when the light point is made it issues the same commands as a switch would. The only difference is that a single photocell can issue up to 14 triggers at different light levels.

**SELECT BTN SWI ID # 5**

**PAGE 1-3**

T1: Exterior Lights

T2: Exterior Passage

T3: South Window Lights

T4:

T5:

This may seem like an excessive amount of triggers but it does allow some very tricky daylight harvesting scenarios.

On three input cards the 14 triggers are divided amongst the 3 Analog (Photocell) inputs and the three enable inputs plus one additional contact closure input which is not usually mounted on the control card.

Pressing Enter on a Trigger gets to the typical switch load listing page. Fill in the loads that this trigger will control. Scroll to MAINTAIN and press ENTER.

**SW ID 5-1 MAINTAIN**

**EDIT: LCP - 1 LOAD - 1**

LCP1:1

**SENSOR ID # 5-1**

**Analog 1 : 0038**

Time Delay : 5 Mins

On when light level

falls below : 0020

OFF when light level

rises above : 0030

This screen comes up. Typical levels set for an exterior photocell are shown.

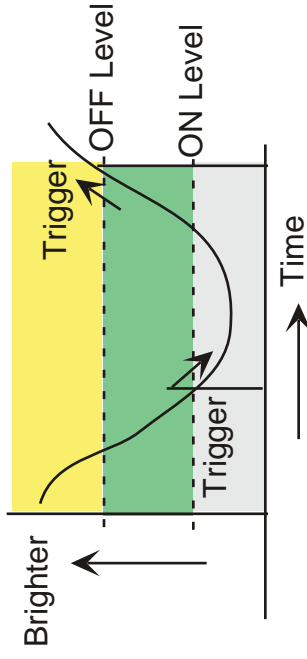

Notice that the direction of increase/ decrease is relevant. Rising through the ON level does not trigger. Only falling through it. The opposite is true of the OFF level.

Set the ON and OFF levels for your application. The current reading of the sensor is shown on the bottom line. The reading is approximately equivalent to foot candles and has the same sensitivity as the human eye.

Time delay may be set from 1 to 30 mins or to 5 seconds for testing.

On a 3 input card "ANALOG 1" may be scrolled through the three analog inputs and 4 digital inputs to choose what is doing the triggering. A Digital (Dry contact switch) does not need trigger levels set.

Highlighting the current reading of light level and pressing enter allows you to select the current sensor to be displayed on the opening page of the Clock display.

PCC3 -Scroll to get:

ANALOG 1

ANALOG 2

ANALOG 3

DIGI 1(Enable1 if on Trigger 11)

DIGI 2(Enable2 if on Trigger 12)

DIGI 3(Enable3 if on Trigger 13)

DIGI 4

Select "Y" to enable or "N" to disable the level of this analog input to be displayed on the initial page.  
Display ? **N** / Y

This shows the screen when you press Enter on the current light reading. If you say "Yes" on Trigger 1 and then use Analog 2 on Trigger 2 and say "Yes" again in this same menu then only Analog 2 will display on the first screen.

### Daylight Harvesting

By using different trigger points it is possible to set up a sequence of light increase and decrease as the light levels change. For example:

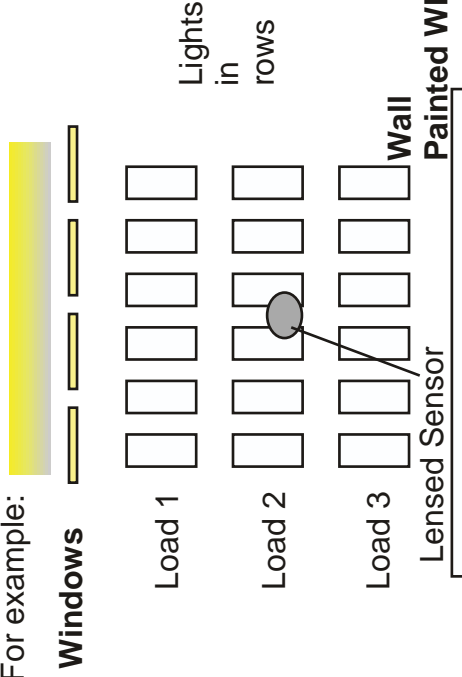

As the brightness increases one could first turn OFF the lights nearest the window (Load 1) then load 2 and lastly load 3. One might set the trigger points of load 1 to be OFF at 120 On at 80 with load 2 OFF at 140 and ON at 100 and Load 3 OFF at 160 and ON at 110.

By having actual number readouts adjustments can easily be made.

### Special Situations

If one is not using a photo-sensor as the analog input or one needs a different type of scenario there are additional options.

Instead of using the MAINTAIN function choose either ON MODE or OFF MODE. Here one only gets one trigger but one can choose the direction of increase or decrease of the variable being measured.

**Sensor ID# 13-1**

**ANALOG 1 : 0014**

**Time delay : 1 min**

**Triggering when light level**

**falls below: 0019**

Scroll on "falls below" to get "rises above".

In the ON MODE the action of the trigger is to turn ON the selected relays or Group. In the OFF mode the action of the trigger is to turn OFF the selected relays or Group.

It may require two triggers in order to accomplish the action that was done with one in the MAINTAIN mode.

### Note on Groups:

Photocells can operate on Groups as well as individual relays. Only the following functions may be used:

- MAINTAIN
- ON MODE
- OFF MODE

**This covers the User Section of the Programmer manual. The Appendix is for more advanced users who may have to configure or re-configure a system.**





**ERROR STATISTICS:**  
 OVERALL: 134  
 ADR8: 120  
 CMD1: 0  
 CLEAR

through the addresses to find out which address the errors are coming from.

Say it is a switch. Investigate that switch to find out what is wrong. Usual problems are an additional terminator or a bad connection. Another possibility is that the switch itself is bad.

Very occasionally one will find an address with a high error rate that has no card or switch. This is usually due to no terminator at the end of the bus resulting in a false echo.

Once a system has been set up there should be no errors on the bus for at least 2 minutes at a time.

Occasionally there will be an error due to noise on the line or a data collision. But these should be rare.

Most items on the bus try 30 times in order to get a question or answer through. Thus the error rate can be very high and yet everything works. The only apparent difference will be that the LEDs will respond slower on a system with more than 10 switches.

**PANEL/SWITCH TYPES MENU**

Once a new switch or board has been addressed it must be defined in this menu. Notice that there are 19 pages of addresses. Scroll through to the correct page and then to

**ADDRESSING PAGE 1-19**  
 ID1 : 2408 as LCP1  
 ID2 : 2404 as LCP 2  
 ID3 : UNUSED  
 ID4 : 2 BTN SWITCH  
 ID5 : 6 BTN SWITCH  
 ID6 : ANALOG 1  
 ID7 : ANALOG 3

the correct address. Then scroll through the options to define the item. For example if it is a switch then scrolling up to say "6 BTN SWITCH" would be appropriate.

Note that if you are adding a control card to an LCP panel then it is important to scroll through the LCPs to assign it to the correct LCP or it will not display in the Switch Button or Group menus.

**RELAY PROPERTIES**

This menu is also available in the non restricted area and is repeated here for convenience.

**REMOTE SYSTEM MENU**

Use this menu for dialing up another DTC 2400 or for setting the password to be used by a remote DTC 2400 in order to access your DTC 2400.

**REMOTE PASSWORD**

This would be more accurately named the dial in password. It is usually set to 001900

## REMOTE SYSTEM MENU

**DIAL UP HOST**  
REMOTE PASSWORD

**Do not change this if you wish the factory to do a down-load or checkout of the system through the modem.**

If you are setting up a campus wide system or multiple venues then by all means choose your own password.

### DIAL UP HOST

Enter the phone number by scrolling numbers up and down and hit enter. Then put in the remote password. Then hit Enter. The system will connect to the modem and dial the remote system. This may take up to 60 seconds to complete all the actions needed. At the end of that time you will be able to see the screen at the far end of the line and control it just as if it were the local system. Response time will be a bit slower than a normal system but not by much.

To end off a remote session go to the USER MENU which will now have an added line of END SESSION at the bottom. Hitting Enter with this highlighted will hang up the modem at both ends and end the session.

### DIALING UP HOST

Enter the complete phone number of the HOST and hit enter

13232246616

### DIALING UP HOST

Enter the password required by the HOST and hit enter.

PASSWORD: 001900

## DIAL IN PASSWORD

In host mode this is the required

Password: 001900

Note 1: If the pass word you typed in is different from the one at the far end it will not connect. There is no warning message about this, it will just not connect.

Note 2: The modem may be connected all the time to a phone line. Wrong number calls must enter a 64 bit system password first before the individual password is entered thus it is almost impossible to "hack" into the system.

## OWNER SETTINGS MENU

This menu allows for changing the name of the system at the opening page. It may seem strange to have it in the restricted section of the menu but there is a reason. This name is set at the factory and recorded there. If we have to phone the system we will then know what system we are talking to.

If you wish to change the name on the first menu then this is where it is done. It uses the same principles that are used in the naming menu.

## ERASE OPTIONS Menu

ERASE BY ADDRESS BUTTON will erase everything in a board **except it's address**. For a switch this means that it will erase its name, the name of the buttons and what those buttons control . For a relay card it will erase the special functions set up in that card with the Relay Parameters Menu, it will erase all groups that operate on that board, it will erase the timers that are programmed into the board. It will also erase any names entered for the loads.

**WARNING !!!**  
While on this screen

Pressing the  
Address/Erase button  
of any board will erase  
board memory.

**WARNING !!!**

While on this screen  
**BOARD 1 IS ERASED**  
Pressing the  
Address/Erase button  
of any board will erase  
board memory.

The erase function is done at the factory prior to programming to get rid of any programming used in testing.

**Erase Clock Memory**

Erase Clock Memory is done at the factory prior to programming to erase any unneeded data that might be in memory left over from testing. Erasing the Clock memory erases the following:

- All Schedules and what the schedules control
- Names of Schedules
- Names of Groups, however it does not get rid of Groups since the data of what is in a group resides on the

**WARNING !!!**

You are about to  
**ERASE ALL MEMORY !**  
Select 'NO' if you  
are not sure

**NO/YES**

relay cards.

Name of the owner

It sets the Password to 0000

All holiday lists are set to NO

Options are set to their default values

Location is set to Los Angeles

The ID numbers (addresses) of relay and switch cards and the type of card they are as listed in the PANEL/SWITCH TYPES Menu. (It does not erase the card's addresses, just the record of them in this menu. )

It does not erase the following:

- Names of Switches, Buttons , Zones since these are kept on the switch and relay cards.
- What relays are in a group.
- The correct time and date. (But not the correct sunrise and sunset since location defaults to Akron, OH.)

### Changing the Mode on a GR 2416 Card

As covered earlier in the Manual the GR 1416 card and the GR 2432 or GR 2448 cards may be sent out from the factory in one of three different modes.

- a) 8 Zones
- b) 16 Zones
- c) Discrete or 1 zone per relay.

It is possible to change the mode of the card in the field. When the mode is changed the Groups and any other board level parameters will be erased. The address positions that the board occupies will also be set to Zero.

If changing a 16 zone card with 48 relays to a 48 zone (Discrete Mode) card an additional 4 addresses will be required. In other words, if the card was previously addressed as # 4 it would also have occupied address # 5. This can be seen in the PANEL/SWITCH TYPES MENU on the first page of the RESTRICTED or FACTORY SET UP MENU. Changing the card to a 48 zone card will now take up addresses 4 through 9. Check it out on the PANEL/SWITCH TYPES MENU after it has been changed or leave the clock on that menu as the change is done and observe it.

If the system was addressed at the factory these addresses are usually left unused. The only reason to use them up would be if the system is running out of address space.

If changing the Mode of the board check out the PANEL/SWITCH TYPES MENU first to make sure that the necessary address space is free.

GR 2416 Card

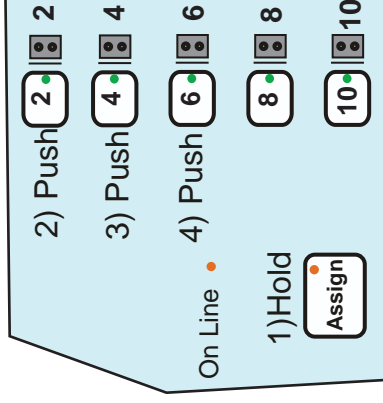

GR 2416 Card

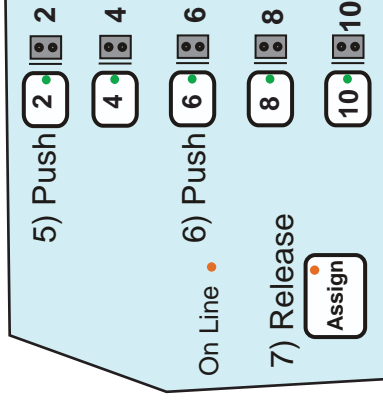

### Mode Changing Steps

- a) Press and hold the ASSIGN button on the GR 2416 card. After three seconds the relay LEDs will go out and the Mode indicating LEDs will be lit.
- b) Now press the following Key Sequence on the relay buttons:  
2,4,6,2,6
- c) Let go of the ASSIGN button. After about 5 seconds any relays that were ON will turn OFF and the board will have changed state. The state that it has changed into will be the next state in the sequence shown below:

- 8 Zone
- 16 Zone
- Discrete
- 8 Zone etc.

Thus to get from an 8 zone to a Discrete Mode one has to do the sequence twice.



Double check the mode one is in by pressing and holding down the ASSIGN button for more than 3 seconds.

## **Appendix II**

### **Checklist for GR 2400/1400 System Start Up**

**Next Page**

## Appendix II

- 1) Verify that the system is complete against the bill of materials. Check that all switches and photocells listed have been included and are now mounted.
- 2) Check that the system power has been connected to the correct terminal on the Transformer input block. (120 or 277 volts.) Make sure that this is a dedicated circuit rather than in parallel with a load that might blow and pull the whole system down.
- 3) Make sure that the Bus has been properly connected up:
  - a) Ensure that the bus has been run in a straight line as shown at the bottom of the page. There should be no "spurs" of more than a few feet (2-3). The wire must be Cat 5.
  5. Switches on very long runs may need additional wires to boost the voltage at the switch. If suspicious measure the voltage at the switch after step 4. Volts must be above 9 volts dc between the 0 and +12 volt 2 pin connectors.

- b) This should have been done as the connecting cables between each point were made up. If not then go through the entire bus with a cable tester. Testing each section of cable to make sure there is continuity and no problems with the data wires.

## Checklist for GR 2400/1400 System Start Up

- c) Make sure that the system is NOT POWERED. There should not be any power on any control card. Having verified this, plug in the bus to all boards. Make sure that the bus is **terminated** at the far end. (Note: If terminator shorting jumpers are lost call the factory for the location of a secret spare.) At the first board on the bus remove the terminating jumper and measure Ohms between 2 and 3. (Most relay panels have at least one "1234" connector which allows access to the 4 wires of the bus so that ohm readings can be taken. If "1234" connectors are not present there will be "TEST" points that allow an ohm reading to be taken. Readings should be taken at this connector. Should be approximately 120 ohms plus the ohms due to the wire. (Expect about 48 ohms per 1000ft of #24 awg wire plus the 120 ohms at the far end.) This is a chart of expected values measured on the data pair ONLY.
 

500 Ft with single terminator	144 ohms
1000 ft with single terminator	170 ohms
2000 ft with single terminator	220 ohms
3000 ft with single terminator	270 ohms
4000 ft with single terminator	320 ohms
5000 ft with single terminator!!!	370 ohms

More than 4000 ft the bus must be split. Call Tech Support!

**Remember to replace the terminator at the beginning of the bus!**

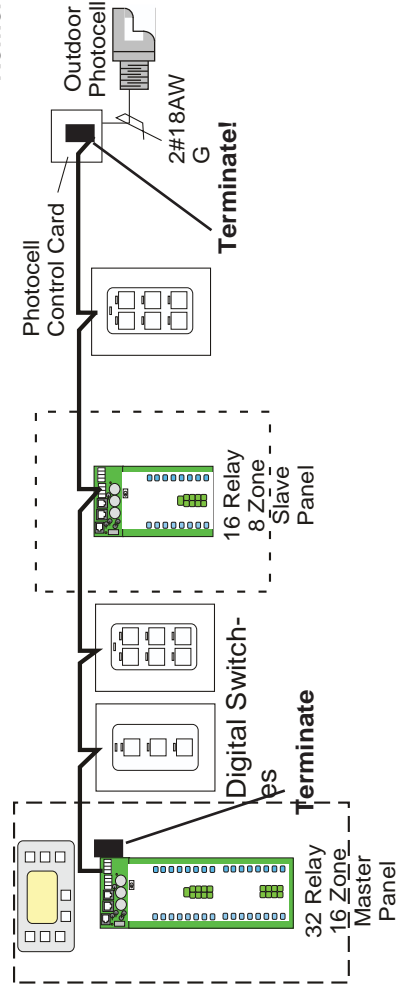

Typical problems that this measurement shows up are:

- i) 3000ft of wire was used on the job yet the bus measures 83 ohms. This shows an extra terminator some place on the bus or that the first terminator was not removed for the test.
- ii) The Bus measures high. By high is meant more than expected up to infinite. This means there is a problem between where you are at the end of the bus. Try again half way down the bus to narrow down the problem location.
- iii) The Bus measures more than 4000ft and now you come to think of it you did use up a lot of rolls of wire. The bus must be split. Call Tech support for help.
- d) Check for Earth ground connections. With the whole bus de-powered measure the ohms from +12v, Ground and A & B of the bus to an earth ground. It must be infinite. If not, find the problem.

4) Now that the bus is verified it is time to fire up the system.

- a) If it is a multi panel system start with panels that do not have a clock in them.
  - i) Unplug the panel from the bus.
  - ii) Turn on the power.

iii) Check that the relays turn ON and OFF using the on board push buttons. Press the center buttons. If they do not work verify that the panel is in the "discrete" mode and use the individual relay buttons.

NOTE: Sometimes the push buttons do not work first time. Use your fingernail to get a high contact pressure onto the control card under the button.

- iv) Check that the voltage being sent to the bus is

about 12 volts + or - 1.5 volts. Do not plug in the bus yet.

- b) Fire up all the other panels that do not have clocks in the same way as above.
- c) Finally fire up the one with the clock and verify as above.
  - i) Note that the clock says the correct time. If time is incorrect go to :SET UP MENU, SYSTEM SET UP, SET TIME AND DATE and correct it. Remember to highlight the HIT ENTER on the bottom of the screen to set the time.

d) Now plug in the bus to each of the panels and switches.

5) Verify that the clock can see everything on the bus.

- a) Navigate through the clock to the SETUP MENU, SYSTEM SET UP, RESTRICTED, (CODE 90001), ADDRESSING BUS SCAN, BUS SCAN DISPLAY.

Note that 3 stands for an 8 relay or 8 Zone board. A 16 zone board would show up as shown above with two threes

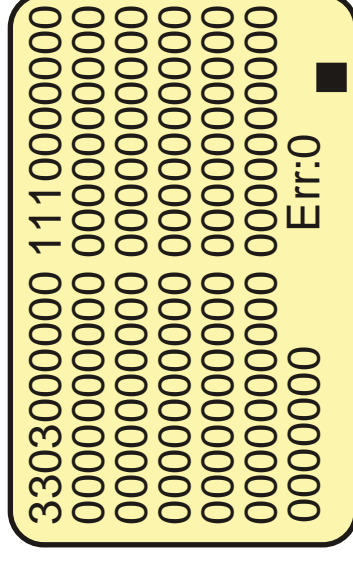

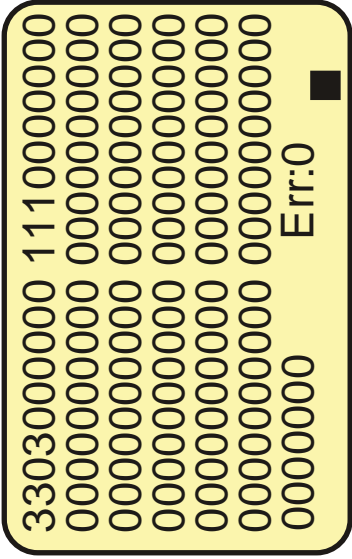

Tab down to clear and press ENTER. Then watch the display for a couple of minutes. If the error count starts rising then highlight the address line as shown and scroll up the address numbers to see which address is giving the errors. If you know there are only addresses up to 10 on the bus do not bother with addresses above.

A switch with a high error count may have an additional terminator on it or should be replaced. It may work but eventually the problem that is causing errors will get worse and the switch will not function. An error count of 0 in one minute is what we are looking for. Systems can function however with the error count just rising away. The reason is that the error count is the number of times the clock tries to communicate to a board and does not get through. It tries thirty or more times if it does not receive an acknowledgment. If data is corrupted due to noise then the receiving switch or board will ignore it. The clock will then retry. This usually results in almost any system having some sort of error count over a period of time. Almost any system will have at least a few errors in 1 hour.

**A high error count with good cards means that the bus has been run too close to high voltage wires.**

A switch on a long bus with an error count may have a terminator on it that should not be there. It may also have too low a dc voltage and need some additional power wire to prevent voltage drop.

at addresses 1 and 2. The 1 stands for a switch, DigiLink or photocell.

The Err:0 is the error count. If the clock cannot see a board for a moment it increments the error counter. This should be zero. If it counts there is a problem with the bus. If a switch is missing or a board is missing then there is probably a problem with that board or switch. (Or it is not plugged in.)

(Also see next step before troubleshooting.)

6) Exit out of the BUS SCAN DISPLAY and tab down to ERROR STATISTICS.

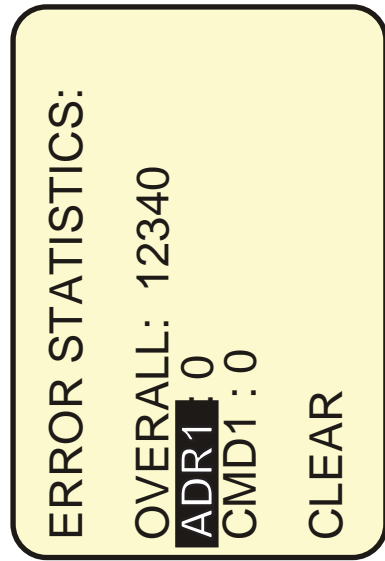

**Wires next to high voltage with dimmers or electronic ballasts are particularly susceptible to noise.**

DigiLink cards with analog switches can pick up noise from the analog switch wires. These should not be run near to power lines and should be shielded if over 100 ft long.

If you have any problems resolving error counts please call the factory at 800 345 4448.

7) Push the buttons on the switches and make sure that they work and that they control the right loads. Verify the action of the system.

8) Call the factory and have them check out the modem if there is one. (800) 345 4448.

9) Train the end users on the operation of the system. Particularly make sure that they understand what a blink warning is (that they need to press the Override Button if they

want the light to stay ON.) Make sure that they know where the switches are.

Also instruct them on how to use the Manual override switch on the cards to turn ON the system in event of catastrophic failure. Alternatively, if they have normally closed relays, turn off the breaker that controls the electronics to relax relays to ON.

Make sure they know our 800 number and tell them that they have free lifetime programming if they bought a modem with the system.

**Always call the factory at (800) 345-4448 for help.  
Definitely call the factory 1 week before  
turn over to the client for final check out.**



### GR 2400 Series Specifications:

Dimensions:

32 Relays : 25.5" High, 20" Wide, 6" Deep

48 Relays : 37.5" High, 20" Wide, 6" Deep

Enclosure: Nema 1 Surface or Flush

Wire: 90 C or above copper wire only.

Number of Relays:

GR 2432: Up to 32 relays

GR 2448: Up to 48 relays

(Note: Two Pole relays take up 2 Single

Pole Relay Spaces

Relays:

SnapLink NO Relay

277Vac at 20 amps Ballast and Tungsten

Rated 100,000 Throws

SnapLink NC Relay

277Vac at 20 amps Ballast and Tungsten

Rated 100,000 Throws

Snaplink 2 pole Relay NO

600V at 20 amps Ballast and Tungsten

Rated 100,000 Throws

Snaplink 2 pole Relay NC

600V at 20 amps Ballast and Tungsten

Rated 30,000 Throws

Snaplink @Zero Relay

277Vac at 20 amps Ballast and Tungsten

Rated 250,000 Throws

### Snaplink SoftStart Relay

120Vac at 20 amps Ballast and Tungsten

Rated 100,000 Throws Brings on load to 1/3 power for approx 1/3 sec before closing the main contact.

Environment:

Temperature of Ambient outside Panel 35 to 105 degrees F

Humidity 10 to 90%

Non condensing.

GR 2400/1400 Bus.

Max Length

4000 ft

Minimum Voltage at any switch or other device on the bus that does not have its own transformer: 9 Volts Dc

Type of wire for most applications:

Cat 5 4 twisted pair with RJ 45 connectors.

Add 2 #18 or better to prevent voltage drop in systems with many switches or long runs.

## Warranty

Lighting Control & Design Inc. warrants each new unit for 36 months from date of shipment to be free of defects in material and workmanship under conditions of normal use and specified ambient temperature when installed and operated under LC & D's product specifications and in accordance with the National Electrical Code.

LC & D shall at its option, repair or replace any defective unit which in its opinion, has not been improperly installed, wired, insulated, used or maintained, provided however that LC & D shall not be required to remove, install or re-install any defective unit and provided that LC & D is properly notified of said defect within the aforementioned warranty period.

Additionally, LC & D shall also replace any relay that fails within the first 36 months under a "no questions asked" exchange policy.

The foregoing warranty and optional remedies are exclusive and, except for the foregoing warranties THERE ARE NO OTHER WARRANTIES OF MERCHANTABILITY OR OF ANY OTHER TYPE. In no event shall LC & D or any other seller be liable for consequential or special damages, nor for any repair work, undertaken without its prior written consent, nor shall LC & D's liability on any claim for damages arising out of or connected with the manufacture, sale, installation, delivery or use of said unit ever exceed the price paid therefore.